

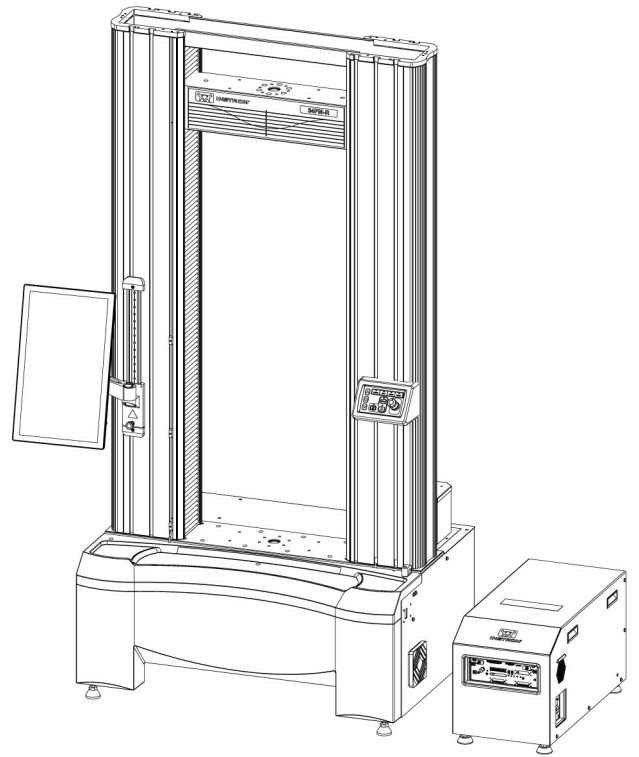

3400 Floor Model Retrofit



Operator's Guide

M10-17569-EN Revision B

Proprietary Rights Notice

This document and the information that it contains are the property of Illinois Tool Works Inc. (ITW). Rights to duplicate or otherwise copy this document and rights to disclose the document and the information that it contains to others and the right to use the information contained therein may be acquired only by written permission signed by a duly authorized officer of ITW.

Trademarks

Instron® is a registered trademark of Illinois Tool Works Inc. (ITW). Other names, logos, icons and marks identifying Instron products and services referenced herein are trademarks of ITW and may not be used without the prior written permission of ITW.

Other product and company names listed are trademarks or trade names of their respective companies.

Original Instructions

Copyright © 2022 Illinois Tool Works Inc. All rights reserved. All of the specifications shown in this document are subject to change without notice.

Worldwide Headquarters

Instron
825 University Avenue
Norwood, MA 02062-2643
United States of America

European Headquarters

Instron
Coronation Road
High Wycombe, Bucks HP12 3SY
United Kingdom

General Safety Precautions



Materials testing systems are potentially hazardous.

Materials testing involves inherent hazards from high forces, rapid motions, and stored energy. You must be aware of all moving and operating components in the testing system that are potentially hazardous, particularly force actuators or a moving crosshead.

Carefully read all relevant manuals and observe all Warnings and Cautions. The term Warning is used where a hazard may lead to injury or death. The term Caution is used where a hazard may lead to damage to equipment or to loss of data.

Instron products, to the best of its knowledge, comply with various national and international safety standards, in as much as they apply to materials and structural testing. We certify that our products comply with all relevant EU directives (CE mark).

Because of the wide range of applications with which our instruments are used, and over which we have no control, additional protection devices and operating procedures may be necessary due to specific accident prevention regulations, safety regulations, further EEA directives or locally valid regulations. The extent of our delivery regarding protective devices is defined in your initial sales quotation. We are thus free of liability in this respect.

At your request, we will gladly provide advice and quotations for additional safety devices such as protective shielding, warning signs or methods of restricting access to the equipment.

The following pages detail various general warnings that you must heed at all times while using materials testing equipment. You will find more specific Warnings and Cautions in the text whenever a potential hazard exists.

Your best safety precautions are to gain a thorough understanding of the equipment by reading your instruction manuals and to always use good judgement.

It is our strong recommendation that you should carry out your own product safety risk assessment.

Warnings



Hazard - Press the Emergency Stop button whenever you consider that an unsafe condition exists.

The Emergency Stop button removes hydraulic power or electrical drive from the testing system and brings the hazardous elements of the system to a stop as quickly as possible. It does not isolate the system from electrical power, other means are provided to disconnect the electrical supply. Whenever you consider that safety may be compromised, stop the test using the Emergency Stop button. Investigate and resolve the situation that caused the use of the Emergency Stop button before you reset it.



Flying Debris Hazard - Make sure that test specimens are installed correctly in grips or fixtures in order to eliminate stresses that can cause breakage of grip jaws or fixture components.

Incorrect installation of test specimens creates stresses in grip jaws or fixture components that can result in breakage of these components. The high energies involved can cause the broken parts to be projected forcefully some distance from the test area. Install specimens in the center of the grip jaws in line with the load path. Insert specimens into the jaws by at least the amount recommended in your grip documentation. This amount can vary between 66% to 100% insertion depth; refer to supplied instructions for your specific grips. Use any centering and alignment devices provided.



Hazard - Protect electrical cables from damage and inadvertent disconnection.

The loss of controlling and feedback signals that can result from a disconnected or damaged cable causes an open loop condition that may drive the actuator or crosshead rapidly to its extremes of motion. Protect all electrical cables, particularly transducer cables, from damage. Never route cables across the floor without protection, nor suspend cables overhead under excessive strain. Use padding to avoid chafing where cables are routed around corners or through wall openings.

Warnings



High/Low Temperature Hazard - Wear protective clothing when handling equipment at extremes of temperature.

Materials testing is often carried out at non-ambient temperatures using ovens, furnaces or cryogenic chambers. Extreme temperature means an operating temperature exceeding 60 °C (140 °F) or below 0 °C (32 °F). You must use protective clothing, such as gloves, when handling equipment at these temperatures. Display a warning notice concerning low or high temperature operation whenever temperature control equipment is in use. You should note that the hazard from extreme temperature can extend beyond the immediate area of the test.



Crush Hazard - Take care when installing or removing a specimen, assembly, structure, or load string component.

Installation or removal of a specimen, assembly, structure, or load string component involves working inside the hazard area between the grips or fixtures. When working in this area, ensure that other personnel cannot operate any of the system controls. Keep clear of the jaws of a grip or fixture at all times. Keep clear of the hazard area between the grips or fixtures during actuator or crosshead movement. Ensure that all actuator or crosshead movements necessary for installation or removal are slow and, where possible, at a low force setting.



Hazard - Do not place a testing system off-line from computer control without first ensuring that no actuator or crosshead movement will occur upon transfer to manual control.

The actuator or crosshead will immediately respond to manual control settings when the system is placed off-line from computer control. Before transferring to manual control, make sure that the control settings are such that unexpected actuator or crosshead movement cannot occur.



Robotic Motion Hazard - Keep clear of the operating envelope of a robotic device unless the device is de-activated.

The robot in an automated testing system presents a hazard because its movements are hard to predict. The robot can go instantly from a waiting state to high speed operation in several axes of motion. During system operation, keep away from the operating envelope of the robot. De-activate the robot before entering the envelope for any purpose, such as reloading the specimen magazine.

Warnings



Hazard - Set the appropriate limits before performing loop tuning or running waveforms or tests.

Operational limits are included within your testing system to suspend motion or shut off the system when upper and/or lower bounds of actuator or crosshead travel, or force or strain, are reached during testing. Correct setting of operational limits by the operator, prior to testing, will reduce the risk of damage to test article and system and associated hazard to the operator.



Electrical Hazard - Disconnect the electrical power supply before removing the covers to electrical equipment.

Disconnect equipment from the electrical power supply before removing any electrical safety covers or replacing fuses. Do not reconnect the power source while the covers are removed. Refit covers as soon as possible.



Rotating Machinery Hazard - Disconnect power supplies before removing the covers to rotating machinery.

Disconnect equipment from all power supplies before removing any cover which gives access to rotating machinery. Do not reconnect any power supply while the covers are removed unless you are specifically instructed to do so in the manual. If the equipment needs to be operated to perform maintenance tasks with the covers removed, ensure that all loose clothing, long hair, etc. is tied back. Refit covers as soon as possible.



Hazard - Shut down the hydraulic power supply and discharge hydraulic pressure before disconnection of any hydraulic fluid coupling.

Do not disconnect any hydraulic coupling without first shutting down the hydraulic power supply and discharging stored pressure to zero. Tie down or otherwise secure all pressurized hoses to prevent movement during system operation and to prevent the hose from whipping about in the event of a rupture.



Hazard - Shut off the supply of compressed gas and discharge residual gas pressure before you disconnect any compressed gas coupling.

Do not release gas connections without first disconnecting the gas supply and discharging any residual pressure to zero.

Warnings



Explosion Hazard - Wear eye protection and use protective shields or screens whenever any possibility exists of a hazard from the failure of a specimen, assembly or structure under test.



Wear eye protection and use protective shields or screens whenever a risk of injury to operators and observers exists from the failure of a test specimen, assembly or structure, particularly where explosive disintegration may occur. Due to the wide range of specimen materials, assemblies or structures that may be tested, any hazard resulting from the failure of a test specimen, assembly or structure is entirely the responsibility of the owner and the user of the equipment.



Hazard - Ensure components of the load string are correctly pre-loaded to minimize the risk of fatigue failure.

Dynamic systems, especially where load reversals through zero are occurring, are at risk of fatigue cracks developing if components of the load string are not correctly pre-loaded to one another. Apply the specified torque to all load string fasteners and the correct setting to wedge washers or spiral washers. Visually inspect highly stressed components such as grips and threaded adapters prior to every fatigue test for signs of wear or fatigue damage.

Table of Contents

Chapter 1: Preinstallation information	13
Dimensions and weight	13
Retrofit Controller	13
Bluehill® Operator Dashboard	14
34FM-Retrofit Power Requirements and Cords	15
Power Requirements	15
Power Cord Selections	15
Noise levels	16
Chapter 2: Introduction	19
System Description and Terminology	20
Components	21
Principle of Operation	23
Hardware Controls	23
Software	23
System Safety and Information Labeling	24
Product Support	25
Product Documentation	26
Chapter 3: Risk reduction and safe use	27
Residual risks	27
Rapid crosshead motion	28
Pinching fingers between grip jaw faces	30
Impact of debris from breaking specimens	31
Collision Mitigation	32
Ingress Protection	32
Solid particle ingress	33
Liquid ingress	33
Operator Protection Overview	34

Chapter 4: Installation	37
Power supply compatibility	37
System components	38
Load frame connections	39
Retrofit Controller	39
Bluehill® Operator Dashboard	42
First time startup	45
Chapter 5: Function of controls	47
Power switch	47
Emergency Stop button	48
Frame Control Panel	49
Bluehill® software	51
Home Screen	51
Operator Protection	53
Operating Modes	53
Move between modes	57
Jog at High Speed	60
Operator Protection Controls	61
Bluehill® Operator Dashboard	62
Basic touch functions	62
Touchscreen gestures	63
Pneumatic Grips	63
How Operator Protection works with grips	64
Operate grips using footswitch	66
Operate grips using toggle switches	68
Grips not in use	70
Chapter 6: Assemble the load string	71
Chapter 7: Testing specimens	73
Testing a sample	73
Testing with no interlock	74

Testing with an interlock.	77
Create a new sample	80
Calibrate a transducer	81
Automatic calibration of a force or strain transducer.	81
Manual calibration	82
Set the zero displacement point	85
Crosshead limit stops.	85
Set the crosshead limit stops	86
Move Off a Crosshead Limit Stop	87
Set the limits for a transducer.	87
Balance a transducer configuration	87
Stop a test.	88
Emergency Stop Button	88
Crosshead Limit Switches	90
Software Event	90
Shut down the system	90
Turn the system off.	90
Troubleshooting	91
A Software Transducer Limit Trips	91
A Crosshead Travel Limit Trips	91
You press the Emergency Stop button	92
Chapter 8: Maintenance	93
Preventive Maintenance.	93
Load frame maintenance.	94
Retrofit Controller maintenance	94
Ancillary parts	94
Parts list	94

Chapter 1

Preinstallation information

This chapter provides information that you need in advance to facilitate installation of your retrofit system.

Dimensions and weight

Retrofit Controller

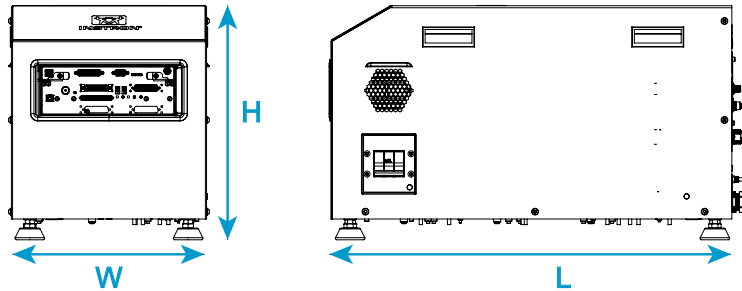

Component	Height (H) mm (in)	Width (W) mm (in)	Length (L) mm (in)	Weight kg (lb)
Retrofit Controller	414 (16.3)	355 (14)	746 (29.4)	21.4 (47)
Retrofit Controller packaged	635 (25)	483 (19)	838 (33)	34 (75)
Full set of accessories packaged	940 (37)	889 (35)	1168 (46)	70.5 (155)

Refer to “[System Description and Terminology](#)” on page 20 to see a typical system layout and note the following:

- the Retrofit Controller can be placed on either side of the load frame or on a bench or shelf adjacent to the load frame
- the cables connecting the load frame to the Retrofit Controller are 2.95 m (9.7 ft) long
- the Retrofit Controller power cable is 4.6 m (15 ft) long

Bluehill[®] Operator Dashboard

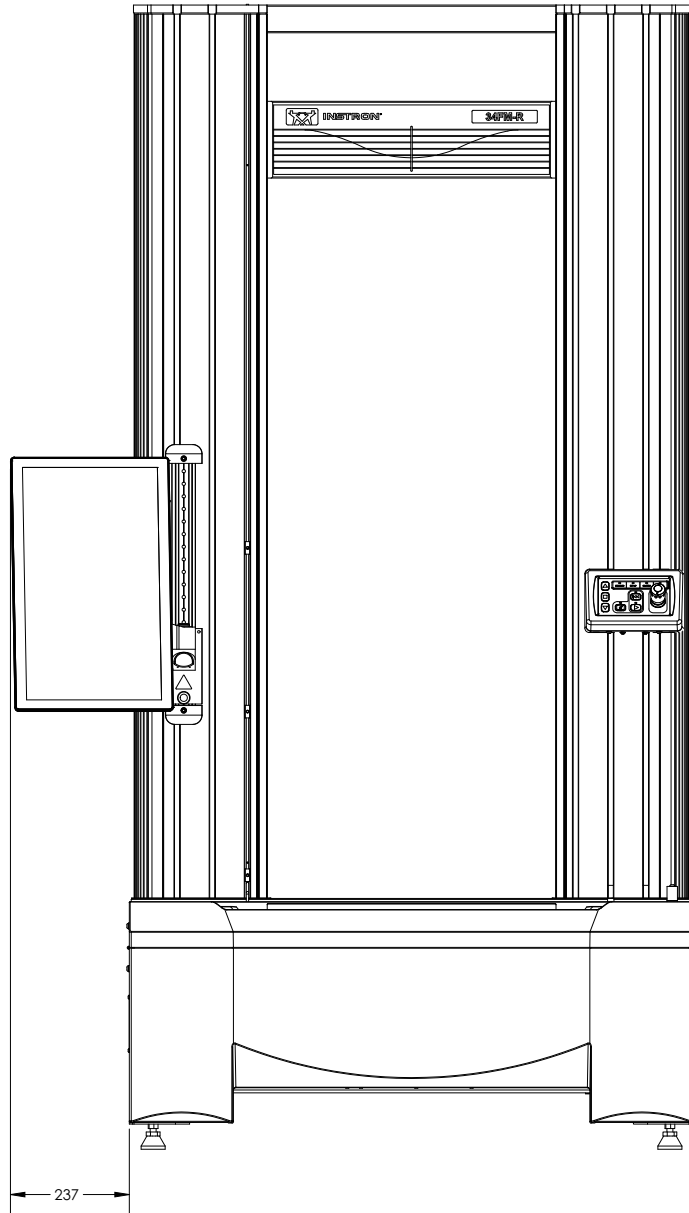

Figure 1. Frame dimensions - including dashboard

The weight of the Bluehill[®] Operator Dashboard and its mounting kit is 2.4 kg (5.2 lb).

34FM-Retrofit Power Requirements and Cords

Power Requirements

Table 1. 34FM-Retrofit power requirements

Parameter	Specification
Maximum Power (VA) (value depends on original load frame model, system label on Retrofit Controller denotes rating)	2400 or 3000
Single Phase Voltage (Vac) (-5% / +10%)	208 to 240
Recommended circuit breaker (required between the facility power source and the load frame to accommodate high in-rush currents at switch on).	1 or 2 pole, 16 A to 20 A
Frequency - Hz	47 to 63

Warning



Electrical hazard - to ensure safety and Electromagnetic Compatibility (EMC) the facility's receptacle must be a 3-wire grounded receptacle. The ground must be a low impedance earth ground in accordance with national and/or local regulations.

Warning



You must use RCD (residual-current device), also known as GFCI (Ground Fault Circuit Interruption), protection on all power sources if your testing system includes water or any other fluid.

If your system includes any fluids (e.g. water-cooled grips, BioPuls baths, food testing fixtures), you must use RCD protection on all power sources to protect the operator from fluids that might leak into the load frame electronics.

Power Cord Selections

When you place your order you can choose the voltage required. If you do not make a choice, Instron chooses the cord according to the customary voltage that matches the shipping destination for the system.

Instron provides the appropriate male plug, as shown in the following tables. It is the customer's responsibility to provide the appropriate female receptacle for the plug.

If desired, the plug may be removed for a direct wire installation.

Table 2. Shipping destination in North America



Voltage and Phase	Plug supplied
208/240 single phase	NEMA L6-20P (250V, 20A, 3-wire) 

Table 3. Shipping destination outside North America

Voltage and Phase	Plug supplied
208/240 single phase	IEC 60309 (blue, 250V, 16A, 3-wire, 2P+E) 

Noise levels

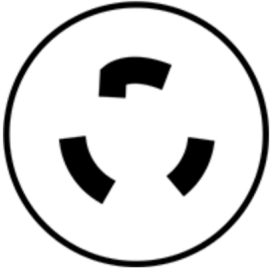
Noise levels do not include noise from specimen breaks.

The noise values are measured at ear level at a distance of one meter at various locations all around the machine.

When idle or operating at low speed, the noise output is 50 dB(A) for all frames except the 5985, where noise output can reach 55 dB(A) and hearing protection may be required.

The A-weighted sound power level emitted by the machinery may exceed 80 dB(A).

When operating at maximum speed, e.g. jogging or returning the crosshead, the noise output can reach 85 dB(A) and hearing protection may be required.



The noise level of the entire system depends on your particular system configuration. Refer to the documentation supplied with other system components for information about that component's noise level.

The noise output from equipment used for materials or structures testing is also dependent upon the items under test. Instron recommends that users carry out their own noise level measurements to ensure the continuous safety and comfort of personnel.

Chapter 2

Introduction

• System Description and Terminology.....	20
• System Safety and Information Labeling.....	24
• Product Support.....	25
• Product Documentation.....	26

These instructions are intended to get you started working with your testing system. They assume the following:

- you are an operator familiar with the operation of materials testing systems in general
- your system consists of a load frame, a Retrofit Controller, a load cell, a set of manually-operated grips and Bluehill[®] test control software
- the system has been installed by an Instron[®] service engineer
- Bluehill[®] test methods that are appropriate for your testing requirements are available

These instructions include the following information:

- installing and connecting all the system components together (carried out by an Instron[®] service engineer for first-time installation)
- configuring the system before you start testing (carried out by an Instron[®] service engineer for first-time installation)
- spare parts

Using these instructions you will be able to:

- check the interconnections between all elements of the basic system
- prepare a set of specimens (sample) for testing
- test the sample
- view the test results and print a test report.

These instructions do not include the development of Bluehill[®] test methods. This is covered in more advanced training that can be provided by the Instron[®] Service and Training departments.

System Description and Terminology

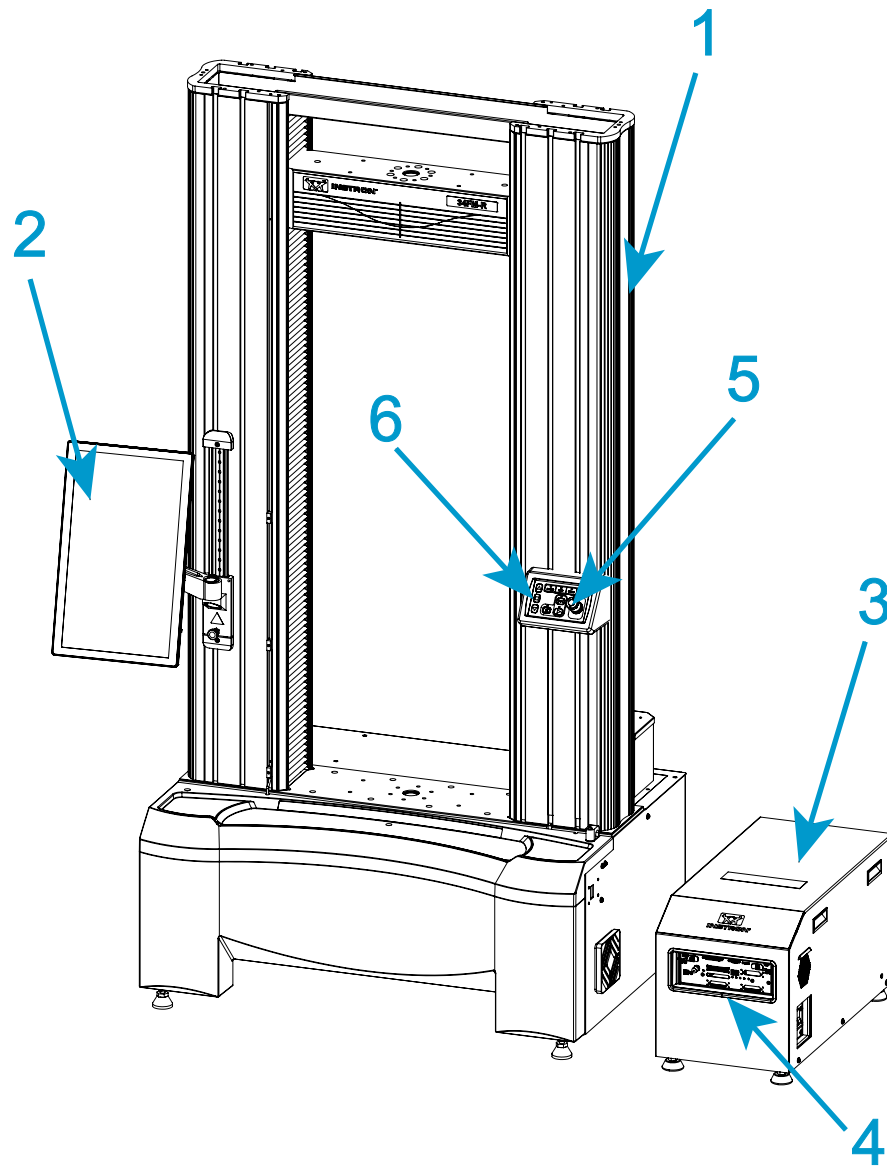

Figure 2. 3400 Floor Model Retrofit with Bluehill[®] Operator Dashboard

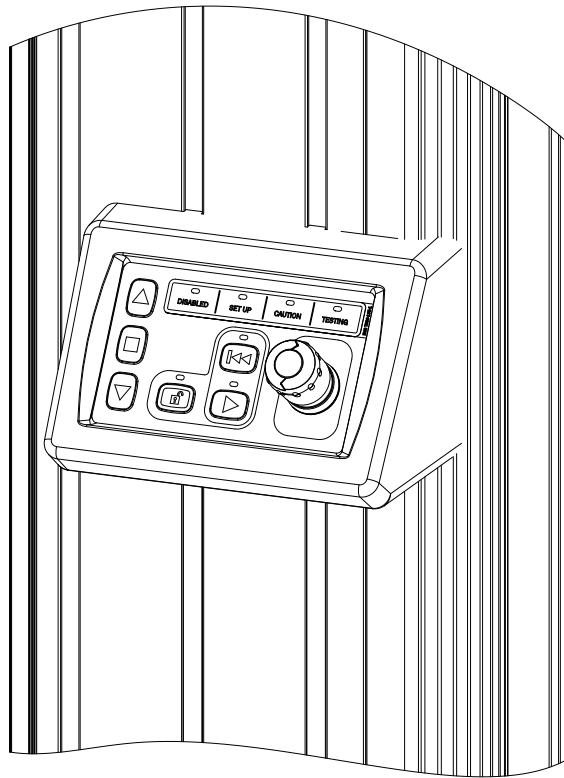

Figure 3. Enlarged view of Frame control panel and Emergency stop button

Legend for [Figure 2](#)

Label	Component
1	Existing floor model load frame (3382A frame shown)
2	Bluehill [®] Operator Dashboard (optional)
3	Retrofit Controller
4	Controller panel
5	Emergency stop button
6	Frame control panel

Components

The major components of an Instron[®] retrofit electromechanical testing system include:

- Load frame to be retrofitted
- Retrofit Controller
- Load cell mounted to the crosshead
- Grips for tension testing or table-mounted anvils on a platen for compression testing.
- Bluehill[®] Operator Dashboard with Instron Bluehill[®] software.

Special fixtures are available for applications such as flexure and peel testing. For strain measurement, an optional strain gauge extensometer attaches to the specimen. You can use non-contacting extensometers with specimens that are unable to support a contacting extensometer. Contact your regional Instron[®] office or check our web site at www.instron.com for assistance with Instron's grips and fixtures.

The following table defines the components of the testing system:

Table 4. Testing System Components

Component	Description
Load Frame	The load frame comprises a base, one or two columns, a moving crosshead, and a top plate. It is a high stiffness support structure against which the test forces react. Each column comprises a guide column and a ballscrew. The crosshead is mounted on both the guide column and the ballscrew. Rotation of the ballscrew drives the crosshead up or down while the guide column provides stability.
Retrofit Controller	The hardware that controls the frame and any ancillary equipment connected to the testing system. The controller panel contains all the connectors for load cells, extensometers and any other sensors that are required for testing.
Frame Control Panel	This panel holds all of the controls and indicators for the testing system.
Load String	Comprises all of the components that you install between the moving crosshead and the load frame base (or fixed crosshead). Typically this involves a load cell, a set of grips, any adapters that are required to connect the components, and the specimen to be tested. Typically, you mount a load cell on the crosshead, then a pair of grips or fixtures on the load cell and frame base. The grips or fixtures secure the specimen and when you start a test the crosshead moves up or down applying a tensile or compressive load to the specimen. The load cell converts this load into an electrical signal that the software measures and displays.
Bluehill [®] Software	Instron [®] testing software that controls the testing system, running tests and analyzing test data to produce test results.
Specimen	A single piece of material to be tested.

Principle of Operation

The system communicates primarily through the controller. The controller contains sensor conditioning cards for the system transducers and transfers data between the transducers and the computer. The controller also communicates with the load frame via a Safety Monitoring Board (SMB) via a Break Out Board (BOB) inside the load frame. The Break Out Board links all the electrical components of the frame together.

Hardware Controls

The hardware controls consist of:

- Emergency stop button - to be used whenever you need to stop the crosshead immediately because an unsafe condition exists.
- Limit stops - these must be set before each test session to protect the operator and load string components against unexpected crosshead movement.
- Frame control panel - holds all the controls and indicators for the testing system.

Software

Control of the testing system is carried out via Instron Bluehill[®] software. Setting test parameters, operating the system, and collecting test data is done through the software program.

Table 5. Software Terminology

Term	Description
Test Method	In Bluehill [®] software, a test method is a file that contains a set of defined parameters that the system uses to run tests, analyze the test data, and produce calculated results.
Sample	A group of material specimens, whose properties are studied and compared to gain statistical or quality assurance information. For example, you could take a specimen from different parts of a single manufacturing run of a material to form a sample of the material. The sample is then representative of the complete run and you can test it to ensure that the material quality has remained stable over the complete run. You perform the same test on each specimen in a sample.

System Safety and Information Labeling

Table 6 on page 24 explains the meanings of any safety and information labels that may be attached to any part of the testing system.

Table 6. Safety and Information Labeling Descriptions









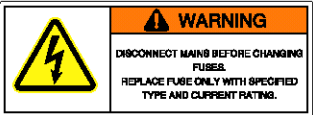

Label	Meaning	Purpose
	Electrical hazard	Indicates that an electrical hazard exists from high voltage and/or electrical current.
	Disconnect power supply	Disconnect the power supply before servicing machine.
	Electrical - fuse warning	Indicates an electrical hazard exists. Advises disconnecting power mains before changing fuses and using only specified fuses.
	Belt entanglement hazard	Indicates that a hazard exists from the drive belt and pulley system.
	High temperature hazard	Indicates that a heat hazard exists. Stay clear of area when operating the machine.
	Rotating machinery hazard	Indicates that a rotating hazard exists. Keep clear of these areas (and tie back long hair and loose clothing).
	Ground stud	Indicates a ground stud.

Table 6. Safety and Information Labeling Descriptions (Continued)

Label	Meaning	Purpose
	Read the manual	Read and understand the operator's manual before using the machine.
	Crosshead direction	Indicates the direction to turn the pulley to manually move the crosshead upward. Pulleys can be turned by hand when power is disabled.
 <p>Crush hazard. Keep clear of test area when machine is in motion. Read and understand operator's manual before using this machine.</p>	Crush hazard	Indicates the crush hazard of the moving crosshead and instructs the user to read and understand the operator's manual before using the machine.
	Waste Electrical and Electronic Equipment (WEEE)	In accordance with the European Union's WEEE directive, the crossed out wheeled bin symbol indicates that the equipment must be disposed of separately from other waste at the end of its usable life. For advice on the disposal of electrical and electronic equipment in your country, contact your local Instron representative.

Product Support

Instron® provides documentation, including manuals and online help, that can answer many of the questions you may have. It is recommended that you review the

documentation sent with the system you purchased for possible solutions to your questions.

If you cannot find answers in these sources, contact Instron® Service directly. A list of Instron® offices is available on our website at www.instron.com. In the US and Canada, you can call directly at 1-800-473-7838.

Product Documentation

Instron® offers a comprehensive range of documentation to help you get the most out of your Instron products. Depending on what you have purchased, your documentation may include some or all of the following:

Operator's Guide	How to use your system components and controls, procedures for setting limits, calibration and other frequently performed operating tasks. Information about system installation, set up and configuration, transducer connection and calibration. Routine maintenance and spare parts.
Preinstallation Manual	System requirements and specifications, instructions for lifting and handling to transport the system to its final location before installation.
Reference Help	Software products come complete with context sensitive help, which provides detailed information on how to use all software features.
Equipment Reference	How to set up and use any accessories you have purchased, for example grips, fixtures, extensometers, transducers, and environmental chambers.

We welcome your feedback on any aspect of the product documentation. Please email info_dev@instron.com with your comments.

Chapter 3

Risk reduction and safe use

• Residual risks	27
• Collision Mitigation	32
• Ingress Protection	32
• Operator Protection Overview	34

Residual risks

The equipment described in this documentation is designed with features to reduce the risk of injury to an operator. There are, however, always residual risks in the use of this equipment, influenced by:

- the test application
- the design of the test method or procedure
- the jog, return and test speeds used
- the type of specimen being tested
- the size of the specimen being tested
- the design of grips and test fixtures
- the experience of the operator using the equipment

It is our strong recommendation, therefore, that you carry out your own risk assessment for your particular equipment setup and testing application.

Each of the following sections describes a specific hazard zone of the testing system and lists the most common risks for testing using this equipment. Use the information in the following sections, together with the instructions in the remainder of this manual, to conduct your own risk assessment.

Rapid crosshead motion

Warning



Crush hazard to fingers or hands.

This hazard relates to grips and fixtures coming together as a result of rapid crosshead motion, crushing hands or fingers.

For example, an operator inadvertently commands the system to jog or return while their hands are in test area. This may also happen if the operator, in an attempt to be more efficient, reaches in to remove broken specimen pieces while simultaneously returning the crosshead to zero displacement.

Recommendations

In all situations:

- Set up test methods so that operators do not need to have their hands in the space between fixtures while the crosshead is moving.
- Use the Operator Protection feature in Bluehill® software. This uses a reduced jog speed (default 600 mm/min) during set up and you can set a lower jog speed if your risk assessment requires it.
- Set appropriate travel limits every time you change the grips and adjust the crosshead.

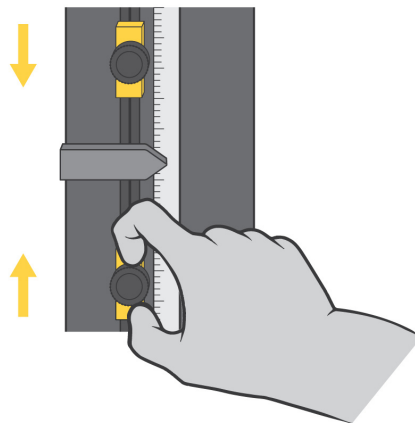

In addition, if the gap between grips and fixtures is less than 50 mm:

- Use a specimen insertion tool and other appropriate equipment and practices to keep fingers out of the space between the fixtures.

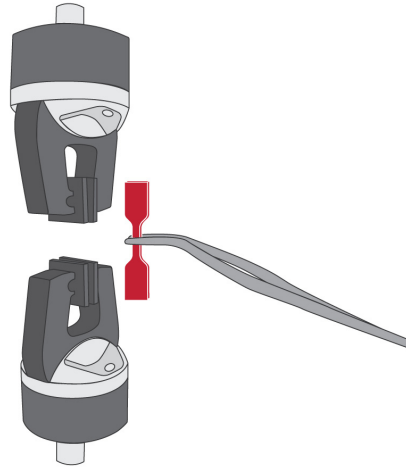

In addition, if the gap between grips and fixtures is less than 25 mm:

- Use a specimen insertion tool to keep fingers out of the space between the fixtures.
- Use an interlocked shield to limit or disallow motion when the shield door is open. When the space is less than 25mm, the crush hazard is very significant, so this is the best option.



Pinching fingers between grip jaw faces

Warning



Pinch hazard to fingers.

This hazard relates to grip jaws closing quickly, pinching fingers.

Recommendations

For 2712 Series pneumatic grips:

- In the documentation supplied with the grips, read and follow the safety recommendations for installing a specimen.
- Use the Operator Protection feature in Bluehill[®] software. This uses a reduced initial grip pressure (default 15 psi) during set up and you can set a lower initial grip pressure if your risk assessment requires it.

Refer to “[Pneumatic Grips](#)” on page 63 for more details.

- Use jaw face shields.

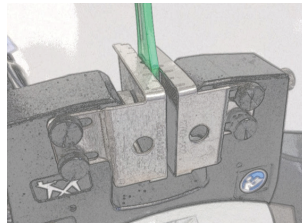

- Use the thumb screw knobs on the sides of the grip (2712-04x grips only) to reduce the jaw face gap to the smallest practical gap for your specimens.

Correct:

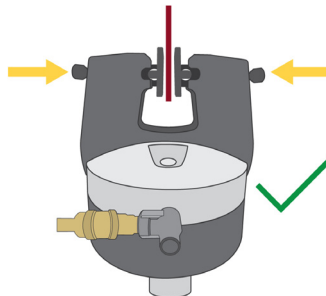

Incorrect:

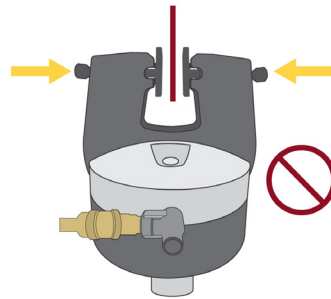

Impact of debris from breaking specimens

Warning



Hazard from flying debris.

This hazard relates to brittle or composite specimens that can explode when they break.

Recommendations

For less dangerous debris (specimen dust or fibers, for example):

- Use personal protection equipment (for example safety glasses).



For more dangerous projectile debris (brittle composite specimens, for example):

- Use an interlocked shield.



Collision Mitigation

The 3400 and 6800 Retrofit Series systems are equipped with the Collision Mitigation feature to help reduce accidental equipment and specimen damage. Collision Mitigation enables the retrofit system to continually monitor force during jog and return operations, and will automatically stop the crosshead movement if an unexpected force is detected.

- On most retrofitted frames, when paired with the system's matching capacity load cell, Collision Mitigation can protect the system from colliding with rigid surfaces at speeds up to 600 mm/min. Although Collision Mitigation is enabled on 4464/5564, 4481/5581 retrofitted frames, while traveling at 600 mm/min, forces may exceed the maximum stated capacity of the load cell due to mechanical characteristics of the frames.
- Collision Mitigation is intended to mitigate damage to the equipment.
- Collision Mitigation is not safety rated, nor safety intended.

Ingress Protection

To comply with relevant safety and machinery design standards, all aspects of the testing system have been designed to meet an ingress protection rating of at least IP 2X. The testing system is designed for indoor use only, away from wet areas.

The first digit of the ingress protection rating (IP 2_) signifies protection against ingress by solid objects. The number “2” indicates that the design prevents any solid object larger than 12.0 mm from contacting any hazardous internal components (e.g. moving parts, electrical hazards) when all covers and guards are in place.

The second digit of the ingress protection rating (IP _X) signifies protection against ingress by liquids. The letter “X” indicates that ingress protection against liquid is not required to be specified for this application. The testing system is protected only against hazards caused by the incidental spillage of liquids.

Note that in many cases, pragmatic improvements against solid and liquid ingress have been implemented in the design to improve durability and longevity of the testing system.

Solid particle ingress

Solid particles and other debris, particularly conductive or abrasive dust (e.g. metal scale, carbon-based composite fibers) may cause damage to the testing system if allowed to accumulate. If your testing application generates debris, follow these special precautions:

- Clean the testing system and adjacent areas frequently with a vacuum or soft brush to prevent any accumulation of debris.
- As part of periodic maintenance, contact Instron[®] Service to inspect the inside of the testing system for accumulation of debris, and clean it if necessary.
- Clean all outer surfaces thoroughly before performing any service. This prevents debris from falling onto the internal components of the testing system.

Liquid ingress

Any liquid spill onto the testing system may cause equipment damage. Incidental liquid spills will not pose a hazard to the operator if properly addressed.

Take particular care when using any accessory that could spill liquid onto the testing system (e.g. condensation from an environmental chamber, BioBath, or hydraulic accessories).

Instron[®] sells a variety of accessories, such as drip trays, that can be used to reduce the impact of spilled liquids on your testing system.

If a liquid spill occurs:

1. Discontinue testing immediately and turn off the power to the equipment. Unplug the power cord (if applicable).
2. Clean up as much spilled liquid as possible on the outside of the equipment. Be sure to check underneath rubber mats (if present) and any installed accessories.
3. If you have reason to believe that liquid entered the testing system, contact Instron[®] Service.
 - a The service engineer will remove the covers of the equipment and clean up all traces of spilled liquid.
 - b Any components damaged by liquid may need to be replaced.
 - c The service engineer will perform an operational check to verify proper function of safety systems.

Warning



Continuing to operate a testing system after liquid has entered the testing system may pose a hazard to the operator and lead to additional equipment damage.

4. Resume testing only after the liquid spill has been properly cleaned up. If the testing system exhibits any faults or unexpected behavior, discontinue testing immediately and contact Instron[®] Service.

Operator Protection Overview

The majority of hazards for operating materials testing systems are associated with:

- rapid movement of the crosshead causing crush injuries
- rapid closing of pneumatic grips causing pinch injuries

Operator Protection in Bluehill[®] provides a mechanism that lets you limit crosshead jog speed and reduce grip closing pressure while you are setting up a test.

The default conditions during test set up are:

- crosshead jog speed reduced to a maximum of 600 mm/min, and can be set lower if your risk assessment requires it
- grip closing pressure reduced to a default of 15 psi, and can be set lower if your risk assessment requires it.

Refer to “[How Operator Protection works with grips](#)” on page 64 for more details.

Operator Protection lets an Administrator configure the testing system to be consistent with the risk assessment for that system.

Access to the controls for Operator Protection is password protected. If you have Administrator rights you can modify Operator Protection in the Admin tab in Bluehill®.

Refer to “[Operator Protection](#)” on page 53 for more details.

Chapter 4

Installation

• Power supply compatibility	37
• System components	38
• First time startup	45

Power supply compatibility

The power cord set and plug is based on the country to which the frame was shipped and is nominally compatible with the electrical requirements for that country.

Warning



Frames may overheat or suffer damage if connected to a power supply greater than 15% above the configured voltage.

Caution

Frames may not be able to run at rated speeds if connected to a power supply more than 10% below the configured voltage.

Before proceeding with installation, verify the following:

- The equipment voltage is compatible with the main power supply of your facility. You can find this information on the System ID label on the rear of the Retrofit Controller.
- The equipment power cable can reach the electrical power supply with some slack in the cable.
- The plug is compatible with the electrical power outlet.

If your power source is not the voltage originally specified on your purchase order, contact Instron® Service.

Warning



Hazard - Do not remove covers to any component of your system, unless it is specified in a procedure.

There are dangerous voltages and rotating machinery inside the machine that may cause bodily injury or damage to equipment.

Warning



Electrical hazard - to ensure safety and Electromagnetic Compatibility (EMC) the facility's receptacle must be a 3-wire grounded receptacle. The ground must be a low impedance earth ground in accordance with national and/or local regulations.

The equipment operates from a single-phase, two-wire grounded power source that applies 240 volts rms or less between the supply conductors or between the ungrounded supply conductor and earth ground.

The connector on the power cable must be compatible with the power source. If the power cable supplied with your system does not fit your power source outlet, add a male plug to the cable that is compatible with the voltage. Observe the CEE wire color code as follows:

- Brown - high (live)
- Light blue - low (neutral)
- Green and yellow - earth (ground)

System components

Instron[®] Service installs your testing system. These diagrams and instructions are provided as a reference if you need to move the system after the initial installation.

The Retrofit Controller houses all the components required to control the testing system, taking over all control functions from the original load frame, including the power input connector.

The Bluehill[®] Operator Dashboard is mounted on a bracket attached to the frame column.

A new emergency stop button and a frame control panel are installed on the right-hand column cover of the load frame.

You operate the testing system via the Bluehill[®] Operator Dashboard and the frame control panel.

Load frame connections

There are no connectors on the frame when the retrofit is completed. All cables are fixed inside the frame and each one has a unique connector that connects with the appropriate receptacle on the rear of the Retrofit Controller.

Retrofit Controller

The Retrofit Controller houses all the components required to control the testing system, taking over all control functions from the original load frame, including the power input connector.

A set of connectors on the rear panel of the Retrofit Controller connect to the original load frame. The controller panel on the front of the Retrofit Controller replaces any controller panel on the original frame for the connection of transducers and accessories.

The Retrofit Controller may be placed on either side of the load frame, within the limits of the lengths of the cables supplied. The exact location may also be determined by the positioning of any accessories installed on the load frame.

Rear panel connections detail

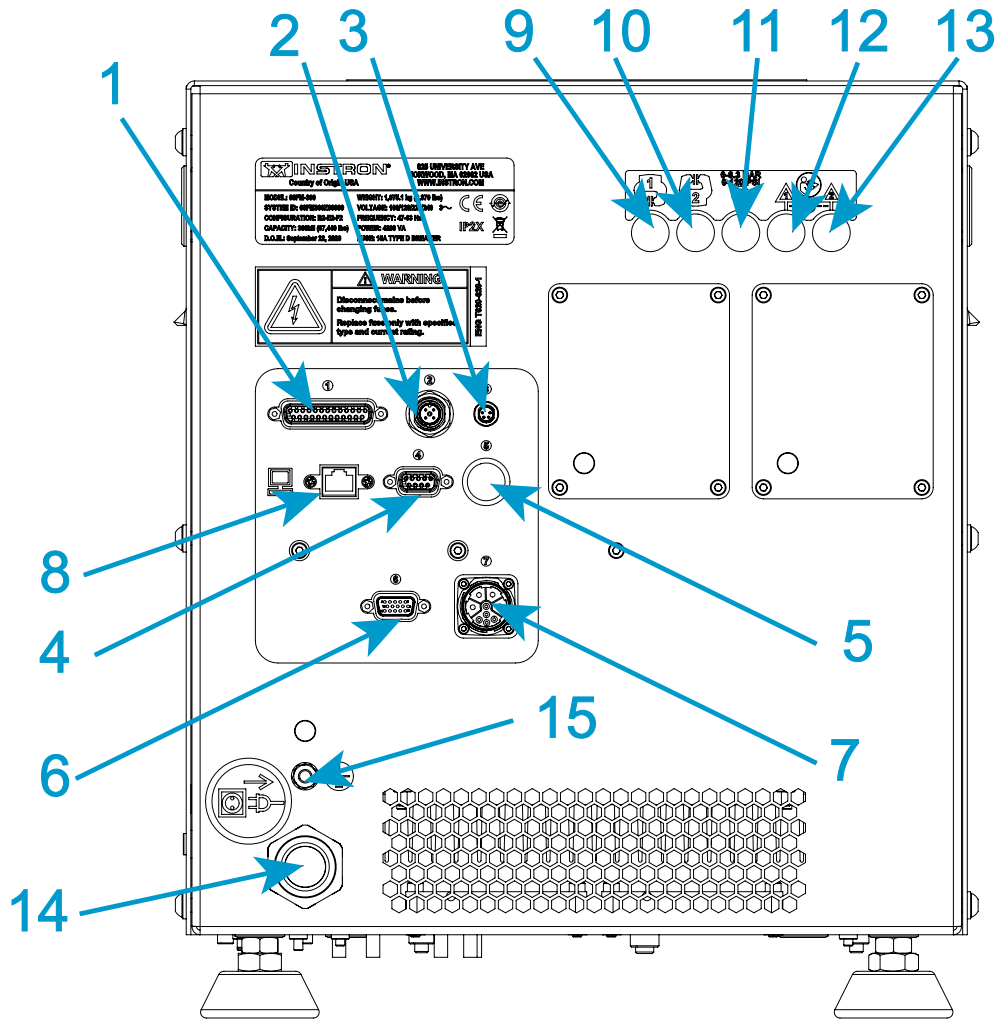

Figure 4. Rear panel connections detail

Legend for [Figure 4](#)

Label	Component	More detail
1	Connection for Frame control panel	
2	Connection for emergency stop	
3	Connection for speed sensor	
4	Connection for limit rod stop	
5	Not used	

Label	Component	More detail
6	Motor feedback (encoder) connection	
7	Connection for motor power	
8	Ethernet (to Bluehill [®] Operator Dashboard) or separate computer	
9	Pneumatic grips - grip 1 connector (typically upper grip)	
10	Pneumatic grips - grip 2 connector (typically lower grip)	
11	Pneumatic grips - air inlet connector	120 psi (8.3 bar) maximum
12	Pneumatic grips - air exhaust connector	Install air muffler or connect to exhaust system
13	Pneumatic grips - air exhaust connector	Install air muffler or connect to exhaust system
14	Power inlet connection	“Power supply compatibility” on page 37
15	Ground connection	Connect to the ground stud on the rear of the load frame using the ground connection cable supplied

Warning



Do not connect the two exhaust ports together.

In some situations, unexpected grip motion can result. To prevent this, do not link the exhaust ports (for example with a “T” or “Y” fitting). The two exhaust ports must remain separate.

Controller connections detail

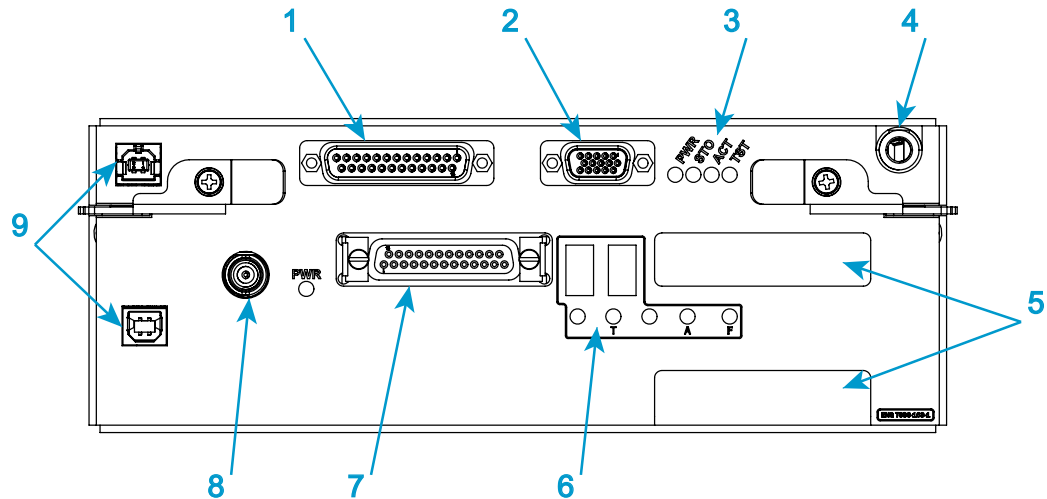

Figure 5. Controller connections detail

Legend for [Figure 5](#)

Label	Component	More detail
1	Encoder connector	Connects to various accessories, including AVE2 and AutoX extensometers
2	Foot switch connector	
3	Status indicators	
4	PIP jack	
5	Strain connectors	Optional
6	Status indicators	
7	Force connector	Connects to load cell
8	Sync connector	
9	Service connectors	For use by Instron® Service only

Bluehill® Operator Dashboard

The Bluehill® Operator Dashboard provides a touch-friendly interface for controlling your testing machine using Bluehill® software.

Adjustment and connection

Instron[®] Service will install the Bluehill[®] Operator Dashboard on your system.

1. You can adjust the height of the Bluehill[®] Operator Dashboard for the comfort of different operators. Loosen the lock (1 in [Figure 6](#) on page 43) and slide the arm mounting (2 in [Figure 6](#) on page 43) to the desired height. Re-tighten the lock.

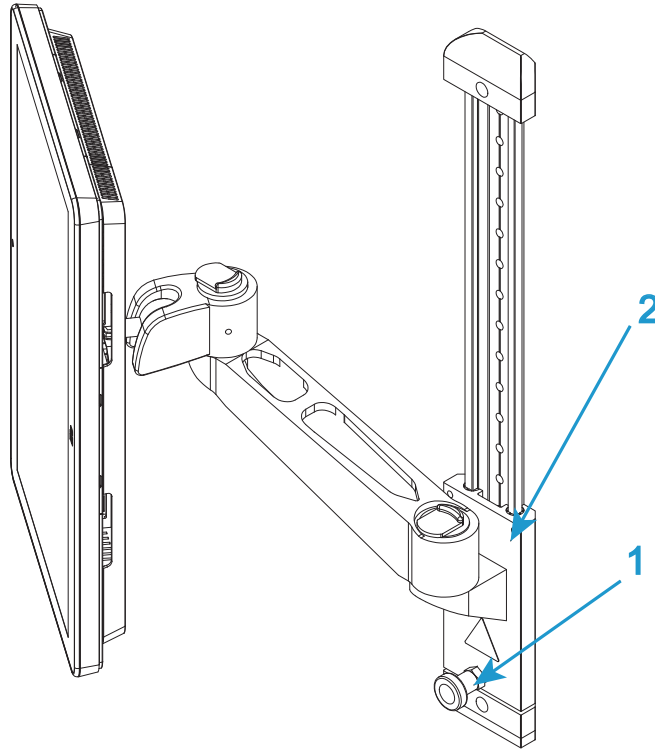

Figure 6. Height adjustment

2. Connect the Ethernet connector on the rear of the Bluehill[®] Operator Dashboard to the Ethernet connector on the rear panel of the testing machine.
3. Connect the mains power cable to the electrical power supply.

Disconnection and moving

If you need to move the testing system you must disconnect and remove the Bluehill[®] Operator Dashboard as follows:

1. Ensure that the power switch is set to Off and the mains power cable is disconnected.

2. Disconnect all cables that connect to or from the Bluehill® Operator Dashboard.

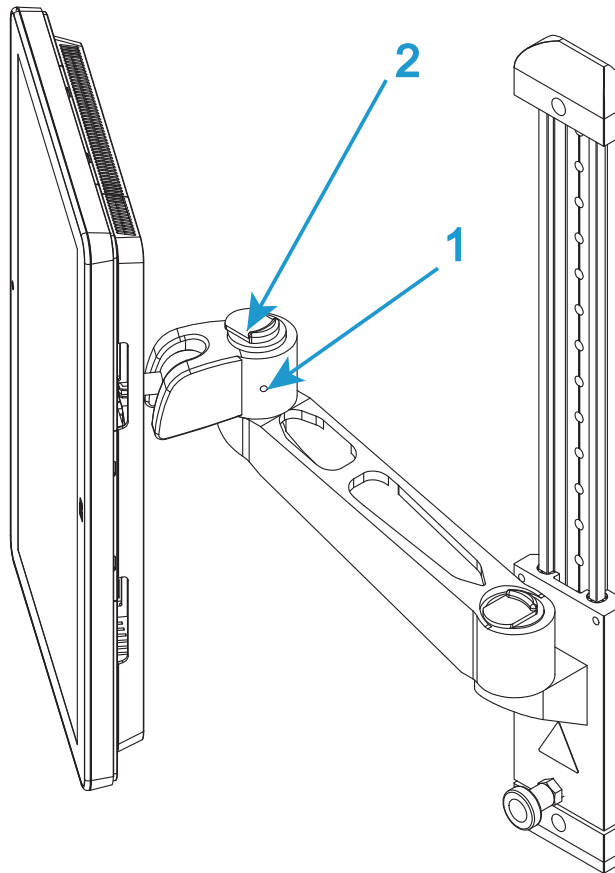

Figure 7. Mounting arm

3. If necessary, loosen the set screw on the side of the “elbow” on the mounting arm (1 in [Figure 7](#) on page 44).
4. Operate the release mechanism on top of the “elbow” (2 in [Figure 7](#) on page 44) and lift the Bluehill® Operator Dashboard clear of the mounting arm ([Figure 8](#) on page 45).

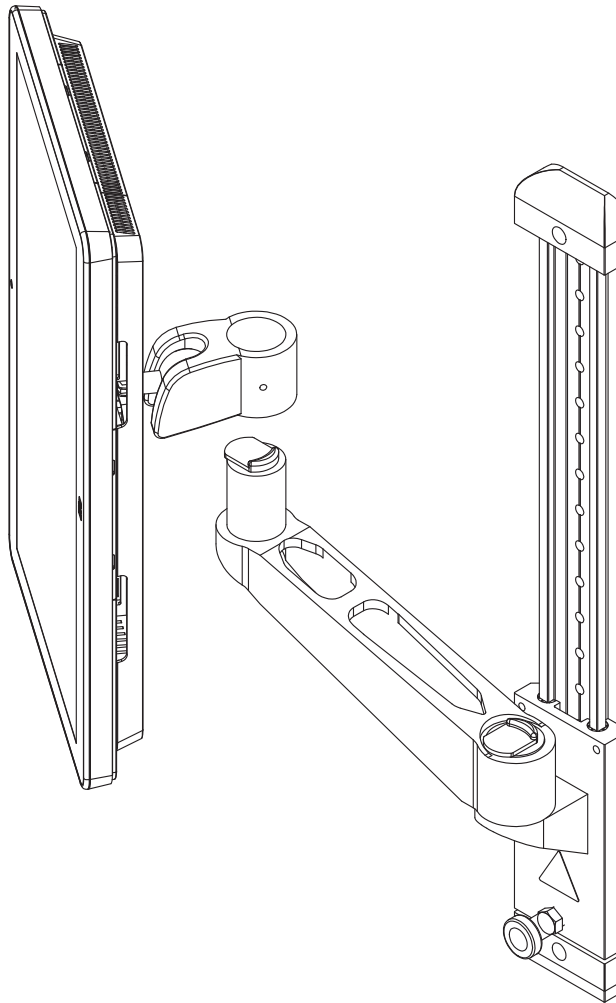

Figure 8. Lift to remove

5. Place the Bluehill® Operator Dashboard face down on a soft material to avoid scratching the screen.

First time startup

When the testing system is installed, you need to configure Bluehill® to communicate with the testing hardware.

1. Ensure that all cables are properly installed and securely connected.

2. Turn the power switch on the machine to the On (1) position.
The white LED above the **DISABLED** indicator flashes.
3. Turn on the power to the Bluehill[®] Operator Dashboard and any other accessories that make up the testing system.
4. Start the Bluehill[®] software.
The first time the software is started, the configuration wizard runs.
5. Follow the instructions in the configuration wizard. The keycode for the software is printed on the media supplied. Steps include:
 - select the controller type and frame model
 - enter the system ID (located on a label on the rear of the frame)
 - enter the Ethernet address (located on a label on the controller panel)
 - enter any additional information, e.g. service contract number
 - select any additional accessories that are installed

If you need to change any of these settings, when you purchase an additional accessory for example, go to the Admin tab in the software.

Chapter 5

Function of controls

• Power switch	47
• Emergency Stop button.....	48
• Frame Control Panel	49
• Bluehill® software.....	51
• Operator Protection	53
• Bluehill® Operator Dashboard	62
• Pneumatic Grips	63

Before you start the system, make sure you familiarize yourself with the following controls:

Power switch

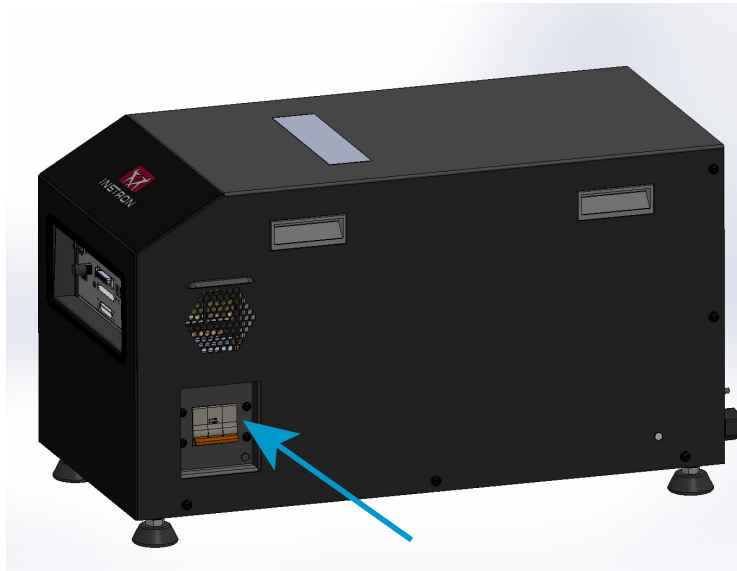

The main power switch is located on the right side of the Retrofit Controller. Select position **1** to turn the power on to the load frame. The **DISABLED** indicator on the frame control panel illuminates. Select position **0** to turn off the power to the load frame.

The power switch is also a system circuit breaker. The switch opens if the demand for current exceeds the system rating, and the load frame electronics automatically shut off and the frame shuts down. The **DISABLED** indicator on the frame control panel stops illuminating. This situation may occur during a test with high loads or speeds that are outside the normal operating envelope of the frame, or when there are large variances in the input voltage.



The circuit breaker only affects the frame electronics. The system's software will still operate. If this occurs during a test, a message displays on the screen advising that the frame is disabled.

Emergency Stop button



Figure 9. Emergency Stop button

The Emergency Stop button is a large, round, red button on the testing system. Press this button to stop the test as soon as possible when a condition develops that:

- could affect the safety of anyone operating the system
- could damage the specimen, load frame, or test fixtures

Warning



If you are using an integrated air kit with a foot switch to control a set of pneumatic grips, be aware that pressing the Emergency Stop button to disable the frame will also deactivate the grips, causing them to open.

With an integrated air kit, any action that disables the frame will also open the grips.

Warning



If you are using hydraulic grips, be aware that pressing the Emergency Stop button to disable the frame will lock the grips in their current position, prohibiting any further motion.

Frame Control Panel

All the controls and indicators for the testing system are on the frame control panel:



Figure 10. Frame Control Panel

Legend for [Figure 10](#)

Label	Description
1	<p>JOG buttons</p> <p>When in SET UP mode, the jog speed is restricted to 600 mm/min or less.</p> <p>When in CAUTION or TESTING mode, the jog speed is unrestricted, i.e. any speed up to the maximum speed for the frame.</p>
2	<p>STOP button</p> <p>Stops crosshead motion, e.g. during jogging, testing, or returning to zero.</p> <p>If you need to disable the frame, press and hold the STOP button for 2 seconds.</p>
3	<p>Mode indicators - different color LEDs that indicate the current mode of the frame.</p> <ul style="list-style-type: none"> • DISABLED (white) • SET UP (blue) • CAUTION (yellow) • TESTING (red)
4	<p>RETURN button - returns the crosshead to zero displacement.</p> <p>Return speed is set in Bluehill[®] software and can be any value up to the maximum speed for the frame.</p> <p>The button is only available after the frame has transitioned to CAUTION mode.</p> <p>When you press this button, the frame runs in TESTING mode until the return is completed.</p>
5	<p>START TEST button - press the button to start a test. Bluehill[®] software must be in the Test screen before you can start a test.</p> <ul style="list-style-type: none"> • The button is only available after the frame has transitioned to CAUTION mode. • When you press this button, the frame runs in TESTING mode until the test is completed or you initiate another action.
6	<p>UNLOCK button - switches the frame between the following modes:</p> <ul style="list-style-type: none"> • DISABLED to SET UP, i.e. enable the frame • SET UP to CAUTION, e.g. prepare to start a test
7	<p>EMERGENCY STOP button - press this button to disable the frame from any mode when a hazardous situation exists. Refer to "Emergency Stop button" on page 48.</p>

The white LEDs above the **UNLOCK**, **TEST** and **RETURN** buttons indicate availability. In [Figure 10](#), the unlock button is available.

Bluehill® software

The software controls:

- setting test parameters
- collecting and analyzing test data

Refer to the Bluehill® online help and reference for more details.

Home Screen

Bluehill® software opens at the Home screen, with the following components:

- Console area at the top and bottom of the screen. Provides important information about the system. Always visible and available from any screen.
- Buttons to access other parts of the software - creating test methods, running tests, analyzing data, producing reports.

Buttons

Table 7. Buttons on the Home screen

Button	Function
Test	Perform tests on specimens. The software displays a sequence of screens where you: <ol style="list-style-type: none"> 1 choose a test method from which to load test parameters. 2 perform tests. 3 name the sample and select a location to store the test data.
Method	Create, edit and save test method files.
Analysis (optional)	Modify an existing sample or replay a sample with parameters from a different test method.
Admin	Change the configuration of the testing system.

Table 7. Buttons on the Home screen (Continued)

Button	Function
Logout	Log out the current user and let a new user log in to the software. When you log out you do not exit the program. This button is hidden if Security is not enabled.
Instron[®] Connect	Uses an Internet connection to check the status of the system, including verification status of transducers. Checks for software updates. You can also use this connection to contact Instron [®] Service for assistance and upload files to Instron [®] Service for diagnosis.
Help	Open the online help.
Exit	Exit the program.

Console area

The console area provides important information during testing and is also where you can edit system wide settings.

At the top of the screen:

- Live displays track values of parameters that you choose
- System button opens the System details dialog where you can view system information, view the event logs, and change settings including:



- set up the load frame and any connected transducers
- set up live displays
- set up soft keys
- set up the test area, specimen protect, jog rate, return rate and collision mitigation
- enable features on pneumatic grips

At the bottom of the screen:

- soft keys that you have set up in the soft keys screen appear here

Status Bar

The status bar appears at the bottom of every screen and provides status information for:

- Security - the name of the currently logged in user or a statement that security is off.
- Machine - is the software connected to a testing machine or running in No machine mode.
- Test type - e.g. tension, compression, metals.
- Sample - the name of the current sample file that is open, if any.
- Method - the name of the current method file that is open, if any.
- Report - the name of the current report template that is open, if any.
- Progress messages - various messages indicating progress, for example “Opening”, “Closing” and “Generating”.

Operator Protection





Operator Protection in Bluehill[®] provides a mechanism that lets you limit crosshead jog speed and reduce grip closing pressure while you are setting up a test.

Operator Protection lets an Administrator configure the testing system to be consistent with the risk assessment for that system.

Access to the controls for Operator Protection is password protected. If you have Administrator rights you can modify Operator Protection in the Admin tab in Bluehill[®].

Operating Modes

Bluehill[®] displays the current system mode corresponding to the four LEDs on the control panel:

DISABLED (white)	SET UP (blue)	CAUTION (yellow)	TESTING (red)
			

Disabled

Bluehill® displays gray border with white text, **Frame is disabled**.

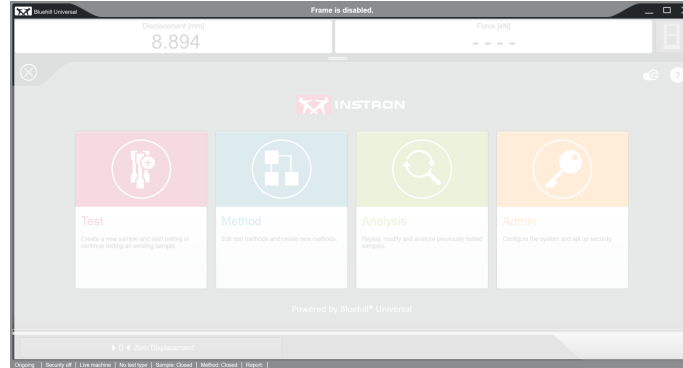

DISABLED (white) LED illuminates on the frame control panel.

This is the default state of the frame upon start up after the software is opened. If the frame is not connected to the software, the LED flashes.

When the frame is disabled:

- crosshead cannot move
- pneumatic grips cannot operate

The frame disables when:

- Emergency stop button is pressed
- A frame fault occurs
- You press and hold the **STOP** button for 2 seconds.

When the frame transitions from any other mode to disabled, any pneumatic grips connected to the integrated air kit will open automatically.

To proceed to **SET UP** mode, you press the **UNLOCK** button.

Set Up

Bluehill® displays blue border with white text, **Ready to set up**.

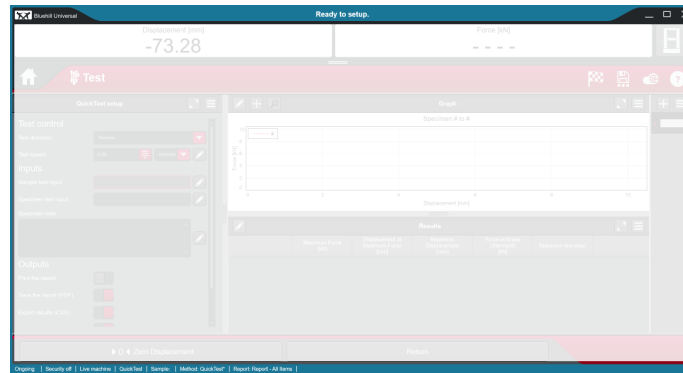

SET UP (blue) LED illuminates on the frame control panel.

This is a restricted state of the frame.



The indicator LED flashes blue whenever the crosshead is moving, e.g. jogging.

When the frame is in set up mode:

- crosshead can jog at the operator protect jog speed (no greater than 600 mm/min)
- pneumatic grips can close at the initial grip pressure (default value of 15 psi)

The frame returns to set up mode when:

- the test is paused (e.g. during extensometer removal)
- after a test is complete
- after a return is complete
- when an interlocked shield is opened

To proceed to **CAUTION** mode, you press the **UNLOCK** button.

Caution

Bluehill[®] displays yellow border with white text, **Ready to test**.

Yellow warning message, **Keep clear of test area**, disappears after a few seconds.

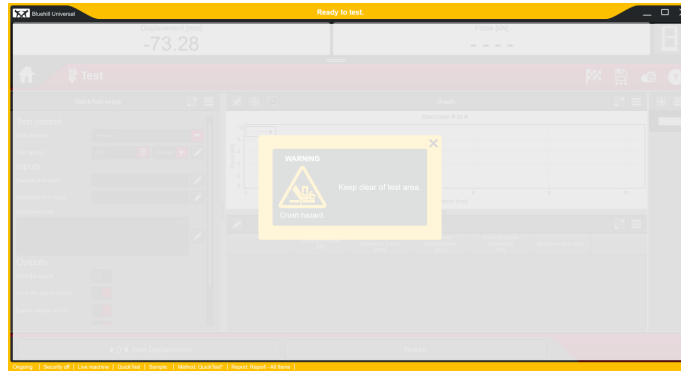

CAUTION (yellow) LED illuminates on the frame control panel.

This is an unrestricted state of the frame.



The indicator LED flashes yellow whenever the crosshead is moving, e.g. responding to the software specimen protect setting.

When the frame is in caution mode:

- pneumatic grips, previously closed at initial grip pressure in the set up state, clamp at full test pressure
- the frame returns to set up mode if a test is not started within 2 seconds (unless a debris shield with interlocks is present and closed)

To start the test, you press the **START TEST** button.

To return the crosshead after completing a test, you press the **RETURN** button.

Testing

Bluehill® displays a red border with white text, **Test in progress**. The border flashes while the crosshead is moving.

Red warning message, **Keep clear of test area**, disappears after a few seconds.

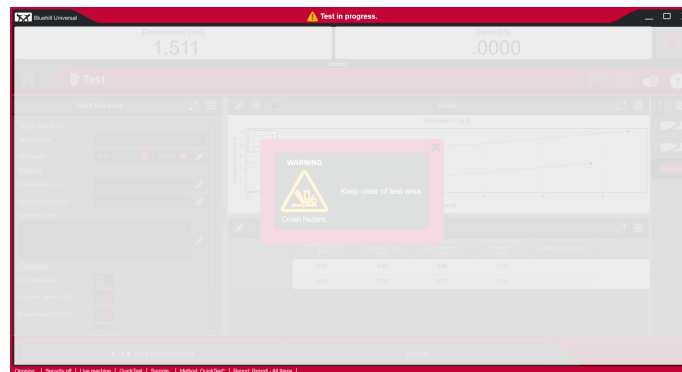

TESTING (red) LED illuminates on the frame control panel and flashes while the crosshead is moving.

This is an unrestricted state of the frame.

When the frame is in testing mode:

- frame is currently running a test
- frame is currently returning to zero displacement after a test

The frame also enters this mode during high-speed jogging, which can be initiated by pressing and holding the **UNLOCK** button while simultaneously pressing one of the **JOG** buttons. Once the jog has started, you can release the **UNLOCK** button so long as you maintain pressure on the **JOG** button. Crosshead speed ramps up gradually to the maximum speed of the frame.

Move between modes

The following table shows how the controls on the frame control panel move the system between modes to set up and run a test.

Table 8. Move between modes



	Initial condition	Action	Result
1	DISABLED (white) 	Press 	SET UP (blue) 

Table 8. Move between modes (Continued)





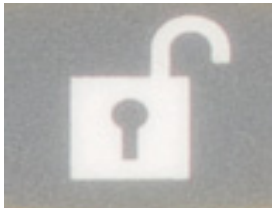





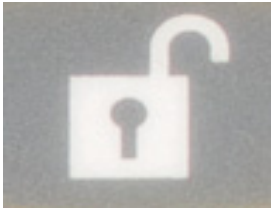

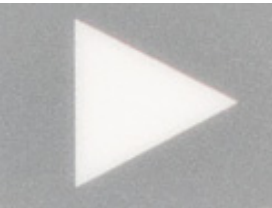
	Initial condition	Action	Result
2	<p>System remains in set up mode until you make a change. During this time you can:</p> <ul style="list-style-type: none"> • move the crosshead at the restricted speed set up in the Admin tab, up to a maximum of 600 mm/min • operate pneumatic grips at the initial pressure set up in the Admin tab, up to a maximum of 15 psi <p>When the specimen is installed and Bluehill® is displaying the Test screen, you can move on.</p>		
3	<p>SET UP (blue)</p> 	<p>Press</p> 	<p>CAUTION (yellow)</p>  <p>Pneumatic grips clamp to full pressure.</p>
4	<p>CAUTION (yellow)</p> 	<p>Press (within 2 secs)</p> 	<p>TESTING (red)</p> 
5	<p>TESTING (red)</p> 	<p>Test runs to completion.</p>	<p>SET UP (blue)</p> 
6	<p>SET UP (blue)</p> 	<p>Press</p> 	<p>CAUTION (yellow)</p> 

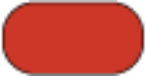
Table 8. Move between modes (Continued)

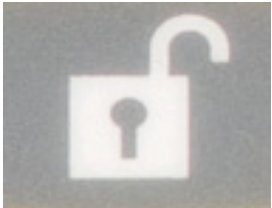
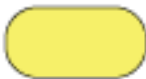
	Initial condition	Action	Result
7	CAUTION (yellow) 	Press (within 2 secs) 	TESTING (red)  Crosshead returns to zero position at speed set in the software.
8	TESTING (red) 	Crosshead returns to zero position.	SET UP (blue) 

Additional notes:

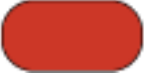
- Once the frame is enabled, the default mode when it is idle is **SET UP** mode with the light above the **UNLOCK** button illuminated. If you want to disable the frame, press and hold the **STOP** button for 2 seconds.
- When you enter **CAUTION** mode, and if you are using a footswitch to control the grips, pneumatic grips clamp to full pressure. If you do not press the **START** button within 2 seconds, the frame returns to **SET UP** mode. The grips, however, remain at full pressure until you run a test. If you are using toggle switches on the grips to control them, the grips are at full pressure only during **TESTING** mode.

Typical test flow

“[Move between modes](#)” on page 57 describes each of the test controls and how they are used to move between testing modes.





For a step-by-step description of a typical test flow using these controls, refer to “[Testing a sample](#)” on page 73. This section contains two procedures, one for systems using an interlock and one for systems without an interlock.

Jog at High Speed

Under normal conditions, in **SET UP** mode, jog speed is limited to 600 mm/min or less. There may be situations, such as moving the crosshead into position at the start of a testing session, where this low speed is inconvenient.

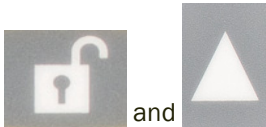
Jogging at high speed involves more risk so the process involves pressing both the **UNLOCK** and **JOG** buttons at the same time, as follows:

Table 9. High speed jog

Initial condition	Action	Result
SET UP (blue) 	Press  and together	TESTING (red)  Crosshead moves up, ramping up to the maximum speed set in the software.
SET UP (blue) 	Press  and together	TESTING (red)  Crosshead moves down, ramping up to the maximum speed set in the software.

Additional notes:

- Although you must press the **UNLOCK** and **JOG** buttons together to start the jog at full speed, you can release the **UNLOCK** button once the crosshead starts to move. The crosshead ramps up to full speed and continues to move while you are pressing the **JOG** button.
- You would typically use this functionality when initially setting up test fixtures and bringing the crosshead to the correct position to install specimens. Thereafter, you can use the **RETURN** button to bring the crosshead back to the zero displacement position.

Operator Protection Controls

If you have Administrator rights, you can make changes to the Operator Protection settings, via **Admin > Frame > Operator Protection**.

For more details on the operation of these software controls, refer to the Bluehill® online help and reference.

Operator Protection options define the restrictions on the system when it is in **SET UP** mode.

Control	Description
Jog rate	<p>Sets the restricted speed of the crosshead when the system is in SET UP mode. Default setting is 600 mm/min, which is also the maximum permitted.</p> <p>If the maximum speed of the crosshead is less than 600 mm/min, then the restricted speed is limited to the maximum speed of the frame.</p>
Initial grip air pressure	<p>Sets the maximum grip pressure allowed when the system is in SET UP mode.</p> <p>Allows the operator to close the grips on the specimen with sufficient pressure to hold the specimen in place but reduces the risk of injury from pinching.</p>
Override point of control	<p>Default is disabled, which means that the primary point of control for the system is at the load frame. The operator must use the buttons on the frame to start a test or position the crosshead.</p> <p>When this option is enabled, the system can be configured to use the software to initiate these actions.</p>
Override point of control - Start test and return	<p>Default is Frame Controls, i.e. start test and return using the buttons on the frame.</p> <p>Only choose Remote if you are using an interlock accessory. The interlock automatically transitions the system to CAUTION mode when the interlock is closed. If there is no interlock, you must press the UNLOCK button to transition to CAUTION mode.</p>
Pneumatic grips	<p>Enables and disables pneumatic grips connected to the testing system with the integrated air kit.</p>

Control	Description
<p>Grip control (when pneumatic grips are enabled)</p>	<p>Default is Footswitch. You close both grips using the integrated air kit and foot switch.</p> <p>Toggle switch lets you use the toggle switches on the grips with the integrated air kit. The footswitch is disabled when you choose this.</p> <p>Remote lets you control the grips via a software program operating through the API.</p> <p>Upper footswitch/lower remote applies only if your test method includes pretension. Upper grip closes with the foot switch and the lower grip closes automatically after the specified load threshold is achieved.</p>
<p>Behavior when the interlock is tripped</p>	<p>If the testing system includes an accessory with an interlock, then Operator Protection defines the behavior of the frame when the interlock is tripped. For example, when an interlocked door is opened and the operator has access to the test area.</p> <p>Disable frame - the frame is disabled when the interlock is tripped. This is the recommended setting as it is the safest.¹</p> <p>Allow limited motion - the frame remains enabled when the interlock is tripped. This allows an operator access to the test area while allowing limited crosshead movement as specified in Operator Protection.</p> <p>Although this option can facilitate installing a specimen or removing an extensometer during a test, it also increases the risk of injury. You should perform a risk assessment before selecting this option.</p>



1. If you choose this option, be aware that the operation of pneumatic grips is also disabled. If you want no crosshead motion when the interlock is tripped but need pneumatic grips to function, select **Allow limited motion** and set **Jog rate** to 0 mm/min.

Bluehill[®] Operator Dashboard

The Bluehill[®] Operator Dashboard provides a touch-friendly interface for controlling your testing machine using Bluehill[®] software.

Basic touch functions

Basic touch screen functions in Bluehill[®]:

- tap a control to select it (equivalent to clicking in non-touch interfaces)
 - to enter text in a field, tap the field and, if the keyboard is not already displayed, tap the keyboard icon to display it
 - to enter numbers in a field, tap the keypad button to the right of the field
 - if there is a task menu associated with part of a screen (accessed via right-click in non-touch interfaces), there will be a Menu button on the screen. Tap it to open the menu.
- 
- if there is a Properties dialog associated with part of a screen, there will be a Properties button on the screen. Tap it to open the dialog.
- 
- enable/disable controls (check boxes in non-touch interfaces) are toggle controls. Tap the control to enable or disable it. Enabled is colored, disabled is gray.

Touchscreen gestures

Gestures supported in Bluehill®:

- graph - pinch to zoom (must also be enabled in the Admin screen)
- test workspace component - if the component is maximized, you can move between components by selecting the appropriate icon in the tool bar below the maximized component
- test workspace setup - when editing test workspace layout, swipe left or right to move between available components
- test workspace specimen selector - swipe up (portrait orientation) or swipe left (landscape orientation) to display a panel that lets you quickly include or exclude a specimen from the sample
- any scrollable screen component - flick up or down, left or right to quickly scroll through the list

Pneumatic Grips

Table 10 on page 64 lists the pneumatic grips recommended for use with these testing systems, combined with the optional integrated air kit and footswitch. They utilize the grip control features of Operator Protection including reduced initial grip pressure, which

reduces the speed and force of closing while setting up a test, thus reducing the risk of injury.

Warning



The Cat. no. 2701-004 air kit and footswitch combination should never be used with any of the grips listed in [Table 10](#) on page 64 nor should it be used with any grips for which it was not originally supplied.

For pneumatic grips which were originally supplied with the pneumatic-only, single pedal footswitch (Cat. no. 2701-004), be aware that these grips and associated air kit and footswitch do NOT utilize any of the features of Operator Protection.

Warning



Always disable the frame before installing or changing pneumatic grips.

When the frame is enabled, the integrated air kit is pressurized. If you attach a grip to the system in this state, the grip could close.

Table 10. Recommended pneumatic grips

Grip model number	Grip capacity
2712-041	1 kN
2712-042	2 kN
2712-045	5 kN
2712-046	10 kN
2712-052	250 N
2712-051	50 N ¹

1. These low capacity grips do not include the toggle switch.

Other pneumatic grips can be used with the system, including operation with the integrated air kit and footswitch, but they may not be designed to utilize the full range of features of Operator Protection. Contact Instron[®] Service for advice.

How Operator Protection works with grips

When in **SET UP** mode, pneumatic grips close at a reduced initial grip pressure. The lower the pressure, the lower the force and speed at which the grips close. You should therefore set this speed to the minimum required to close the grips and grip the

specimen within a reasonable time, but taking into account that even low pressures can cause injury.

The default value is 15 psi. The following table lists recommended initial grip pressures for the pneumatic grips listed in [Table 10](#) on page 64:

Grip model number	Grip capacity	Recommended initial grip pressure - psi (bar)
2712-051	50 N	15 (1.03)
2712-052	250 N	12 (0.83)
2712-041	1 kN	9 (0.62)
2712-042	2 kN	5 (0.34)
2712-045	5 kN	8 (0.55)
2712-046	10 kN	7 (0.48)

Minimum pressure may be slightly higher or lower for any given grip due to age, environmental conditions and use.

Warning



Be aware that even at these recommended initial grip pressures, the force exerted by the closing grips can cause injury.

For example, a 10 kN grip closing at the default initial pressure of 15 psi exerts a minimum force of 4kN (900 lbf). The same grip closing at 7 psi exerts a minimum force of 1.9kN (420 lbf), still a significant force that can cause injury.

Warning



Be aware also that setting initial grip pressure too low may result in the grip not closing completely at the initial grip pressure. This may cause a hazard when the grips transition to full pressure.

If the grips do not close completely at the initial pressure, they will close at full force when the grips transition to full pressure.

Warning



If the grips feature an air inlet flow adjustment control (see below), make sure that the flow adjustment is set to fully open (screw fully counterclockwise).

Do not use the air inlet flow adjustment control to reduce air flow as you risk transitioning from initial pressure to full pressure before the grips have closed. If the

grips do not close completely at the initial pressure, they will close at full force when the grips transition to full pressure.



In addition to the hazard caused by reducing the air flow, operation of the air inlet flow adjustment control can result in an inaccurate grip pressure reading which may disable the frame.

You can remove the air inlet flow adjustment control and connect the 1/8" NPT quick disconnect directly to the grip or via a 1/8" NPT right angle male to female adapter, as shown below.



Operate grips using footswitch

The recommended pneumatic grip configuration is one of the grips listed in [Table 10](#) on page [64](#) combined with the integrated air kit and footswitch.



If for any reason you have to disconnect the footswitch from the frame controller, you must cycle power on the frame to re-establish communication between the footswitch and the frame.

The operation of this configuration with Operator Protection is described in “[Operator Protection using the footswitch](#)” on page 67.

Operator Protection using the footswitch

The point of control for grips in the Operator Protection control dialog must be set to **Footswitch**.

The footswitch operates as follows:

- tap right pedal once, closes grip connected to port 1 (typically the top grip)
- tap right pedal again, closes grip connected to port 2 (typically the bottom grip)
- tap left pedal once, opens both grips

The footswitch integrates with Operator Protection as follows:

- in **SET UP** mode, you can open and close the grips
- in **CAUTION** mode, you can open the grips
- in **DISABLED** or **TESTING** mode, the footswitch does not operate

Warning



If your grips have toggle switches installed, do not use them when the point of control for grips is set to Footswitch.

If you intend to always use the footswitch, you should replace the toggle switches on the grips with the blanking plugs provided with the grips in the ancillary parts kit.

1. Starting with the system in **DISABLED** mode, press the **UNLOCK** button.
The system moves to **SET UP** mode.
2. Operate the system in **SET UP** mode and install the specimen using the footswitch to open and close the grips at the initial pressure set in the software.
3. Press the **UNLOCK** button to transition to **CAUTION** mode.
The grips pressurize to full pressure.
4. Within 2 seconds, press the **START TEST** button to start the test.

If you do not start the test immediately and the system returns to **SET UP** mode, the grips continue at full pressure until you run a test or release the grips.

The system transitions to **TESTING** mode.

5. Stop the test, or the test ends.

The system reverts to **SET UP** mode but the grips are maintained at full pressure until you open them using the footswitch.

Warning



Do not operate the toggle switches when the testing system is in TESTING mode and the grips are pressurized to full pressure. The system may detect an error and disable the frame.

You must not operate the toggle switches when the grips are at full pressure. The grips will open but when you use the toggle switch again to close the grips, the grips will close at full pressure and the system may detect an error and disable the frame.



*You may start a test with one grip closed if desired. If you move to **CAUTION** mode after closing one grip, you cannot close the second grip, even if you transition back to **SET UP** mode. You must use the footswitch to open the first grip in order to proceed.*

Operate grips using toggle switches

The recommended pneumatic grip configuration is one of the grips listed in [Table 10](#) on page [64](#) combined with the integrated air kit and footswitch.

If you are using the integrated air kit but prefer to use toggle switches on the grips instead of a footswitch there are some differences in the operation of the grips that you should be aware of:

- Grips maintain full pressure during **TESTING** mode only. At the end of a test, when the system reverts to **SET UP** mode, the grip pressure reduces to the initial grip pressure. This may cause problems if the specimen has stored energy which could cause the specimen to slip out of the grips. If that is a concern, you should use a footswitch to run your tests.
- You must not operate the toggle switches when the grips are at full pressure. The grips will open but when you use the toggle switch again to close the grips, the grips will close at full pressure and the system may detect an error and disable the frame.

The operation of this configuration with Operator Protection is described in [“Operator Protection using the toggle switches”](#) on page [68](#).

Operator Protection using the toggle switches

The point of control for grips in the Operator Protection control dialog must be set to **Toggle switch**.



If you have a footswitch connected to the system, it will not operate.

Warning



Make sure that the toggle switches are in the open position.

If the toggle switches are in the closed position, the grips will close immediately when the system transitions to SET UP mode.



1. Starting with the system in **DISABLED** mode, press the **UNLOCK** button.
The software displays a message, warning you to make sure that the toggle switches are in the open position.
2. Press the **UNLOCK** button again to transition to **SET UP** mode.
3. Operate the system in **SET UP** mode and install the specimen using the toggle switches to open and close the grips at the initial pressure set in the software.
4. Press the **UNLOCK** button to transition to **CAUTION** mode. The grips are maintained at the initial grip pressure.
5. Within 2 seconds, press the **START TEST** button to start the test.
The system transitions to **TESTING** mode and the grips pressurize to full pressure.
6. Stop the test, or the test ends.
The system reverts to **SET UP** mode and the grip pressure returns to the initial grip pressure.

Caution

If your test ends and the specimen has stored energy, e.g. the specimen did not break, the specimen may slip out of the grips when the grip pressure reduces at the end of the test.

If this could be an issue, it is recommended that you set the point of control for grips to **Footswitch** and use a footswitch for your tests. When using a footswitch, pneumatic grips remain at full pressure after the test ends until you release them using the footswitch.

Warning



Do not operate the toggle switches when the testing system is in TESTING mode and the grips are pressurized to full pressure. The system may detect an error and disable the frame.

You must not operate the toggle switches when the grips are at full pressure. The grips will open but when you use the toggle switch again to close the grips, the grips will close at full pressure and the system may detect an error and disable the frame.

Grips not in use

There may be situations where you want to remove the grips from the load string, placing them on a bench alongside the system perhaps while you perform different types of tests. Be aware that if the point of control for grips is set to **Toggle**, the grips could present a hazard.

Warning



If you remove the pneumatic grips from the load string but do not disconnect them from the integrated air kit, you should disable the grips in the Operator Protection controls in the software.

If the point of control for grips in the software is set to **Toggle**, and you remove them from the load string without disconnecting them from the integrated air kit, the grips will close at initial pressure and cycle between full pressure and initial pressure as you continue your testing.

Chapter 6

Assemble the load string

Refer to the documentation supplied with your original testing system for instructions on how to assemble the load string for testing. These are not affected by the retrofit.

The load string consists of all the hardware components between the crosshead and the base of the testing machine. It includes the load cell, grips, the specimen and any adapters that let you connect any of these components together.

Instron[®] Service sets up the testing machine during installation, but you may need to change one or more of these components for different types of testing.



When creating a load string, keep in mind the maximum capacity for all the components making up the load string. The expected test load should not exceed the maximum capacity of any load string components including, but not limited to:

- load frame
- load cell
- adapters
- grips or fixtures

Chapter 7

Testing specimens

• Testing a sample	73
• Create a new sample.	80
• Calibrate a transducer.	81
• Set the zero displacement point.	85
• Crosshead limit stops	85
• Set the limits for a transducer	87
• Balance a transducer configuration.	87
• Stop a test	88
• Shut down the system.	90
• Troubleshooting	91

Materials testing systems are inherently hazardous. Read the chapter “[Risk reduction and safe use](#)” on page [27](#) before using the testing system.

Testing a sample

The following two procedures are guidelines for steps that you would typically go through when testing a group of specimens. Some steps include references to more detail in separate sections.

These scenarios assume that a test method has already been created that satisfies your testing requirements and provides required test parameters (e.g. specimen dimensions, testing notes) on the test workspace.

The two scenarios describe testing with and without an interlock.

An interlock is an optional accessory that changes the behavior of the system depending on whether the interlock circuit is open or closed. For example, the door on a protective shield may include an interlock. When the interlock circuit is open (e.g. the

shield door is open), the circuit is interrupted and the system is either disabled or restricted as defined by the Operator Protection settings.

Testing with no interlock

This test scenario assumes the system has no accessories with an interlock and that the start test method in Operator Protection settings is set to **Frame control** (the default).

Warnings



Set the load frame limit stops to limit crosshead travel, and set adequate transducer limits to ensure the safe operation of the testing system.

Set all available limits before using the system to avoid crosshead overtravel, contact between grips and fixtures, overloading any component of the load string, or overtravel of a contacting extensometer.



Hazard - do not allow more than one person to operate a testing machine.

Operator injury may result if more than one person operates the testing machine. For example, injury can occur if one person moves the crosshead or actuator while the other is working inside the hazard area between the grips or fixtures.



Crush hazard - take care when installing or removing a specimen, assembly, structure or load string component.

Installation or removal of a specimen, assembly, structure or load string component involves working inside the hazard area between the grips or fixtures. When working in this area, ensure that other personnel cannot operate any of the system controls. Keep clear of the jaws of a grip or fixture at all times. Keep clear of the hazard area between the grips or fixtures during actuator or crosshead movement. Ensure that all actuator or crosshead movements necessary for installation or removal are slow and, where possible, at a low force setting.



Flying Debris Hazard - Make sure that test specimens are installed correctly in grips or fixtures in order to eliminate stresses that can cause breakage of grip jaws or fixture components.

Incorrect installation of test specimens creates stresses in grip jaws or fixture components that can result in breakage of these components. The high energies involved can cause the broken parts to be projected forcefully some distance from the test area. Install specimens in the center of the grip jaws in line with the load path. Insert specimens into the jaws by at least the amount recommended in your grip documentation. This amount can vary between 66% to 100% insertion depth; refer to supplied instructions for your specific grips. Use any centering and alignment devices provided.



Flying Debris Hazard - Brittle specimens may shatter upon failure.

The high energies involved in testing can cause broken parts of a specimen to be projected forcefully some distance from the test area. Wear eye protection and use protective shields or screens whenever a risk of injury to operators and observers exists from the failure of a test specimen.



Select the correct test area for the test. An incorrectly set test area can cause unanticipated crosshead behavior. Press the Emergency Stop button if the frame moves in an unexpected direction.

An incorrectly set test area can cause unanticipated crosshead behavior and create a safety hazard that may damage the specimen or load cell. Verify the test area and test direction before starting a test.

1. Collect all specimens together that will make up the testing sample.
2. Identify each specimen, e.g. by marking. Identifying each specimen helps match it to the appropriate specimen number in the completed sample test report.
3. Start the frame and open the software.

The system is in **DISABLED** mode.
4. Ensure that the crosshead travel limits are set. Refer to [“Set the crosshead limit stops”](#) on page 86.
5. Ensure that limits are set for each transducer (displacement, force, strain, and user-defined). Refer to [“Set the limits for a transducer”](#) on page 87.
6. Press the **UNLOCK** button on the frame control panel to transition the system to **SET UP** mode.

The system is now restricted to the Operator Protection settings specified on the **Configuration > Frame** screen on the Admin tab.
7. In the software, create a new sample file. Refer to [“Create a new sample”](#) on page 80
8. Verify that the test area is correct in System Details. Select **Frame** under Method settings.
9. If necessary, calibrate the transducer configurations required by the test method. Refer to [“Calibrate a transducer”](#) on page 81.

If the frame was previously off, allow the load cell to warm up for at least 20 minutes to ensure stable readings.
10. Measure the required specimen dimensions for each specimen and enter the values into the appropriate fields in the operator inputs component of the test workspace.
11. Use the jog controls to move the crosshead to its starting position and set zero displacement. Refer to [“Set the zero displacement point”](#) on page 85.
12. Balance the Force transducer configuration. Refer to [“Balance a transducer configuration”](#) on page 87

13. Install the specimen into the grips. Refer to the documentation provided with the grips for details.
If the system includes pneumatic grips, refer to [“Pneumatic Grips”](#) on page 63.
14. Verify that the specimen is aligned properly in the grips.
15. Balance each of the remaining transducer configurations, e.g. strain. Refer to [“Balance a transducer configuration”](#) on page 87
16. Press the **UNLOCK** button to transition the system to **CAUTION** mode and then press the **START** button on the frame control panel to start the test.
CAUTION mode remains active for approximately two seconds after the unlock button is released. You must start the test before the system reverts back to **SET UP** mode.
The test will only start if the software displays the test workspace.
17. Upon starting the test, the various components on the test workspace update as the test proceeds. Some components will not update until the test is complete.
18. To stop the test before it completes, press the **STOP** button on the frame control panel.

Warning



In an emergency situation, press the large, round, red button on the frame to stop the test immediately and disable the frame.

Refer to [“Emergency Stop Button”](#) on page 88.

19. After the test is complete, the system transitions to **SET UP** mode.
20. Remove the specimen/specimen pieces from each grip.
If the specimen did not break, use the jog controls to relieve the applied force from the specimen before releasing the grips.
21. Complete any post-test inputs that the test method requires, e.g. final specimen dimensions, specimen notes.
22. If necessary, press the **UNLOCK** button to transition the system to **CAUTION** mode and then press the **RETURN** button on the frame control panel to return the cross-head to its starting position.
When the crosshead returns to its starting point, the system transitions to **SET UP** mode for the next specimen.
23. After all specimens are tested, select **Finish sample** on the Test tab.



Testing with an interlock

This test scenario assumes the system has an accessory with an interlock and that the start test method in Operator Protection settings is set to **Frame control** (the default).

Warnings



Set the load frame limit stops to limit crosshead travel, and set adequate transducer limits to ensure the safe operation of the testing system.

Set all available limits before using the system to avoid crosshead overtravel, contact between grips and fixtures, overloading any component of the load string, or overtravel of a contacting extensometer.



Hazard - do not allow more than one person to operate a testing machine.

Operator injury may result if more than one person operates the testing machine. For example, injury can occur if one person moves the crosshead or actuator while the other is working inside the hazard area between the grips or fixtures.



Crush hazard - take care when installing or removing a specimen, assembly, structure or load string component.

Installation or removal of a specimen, assembly, structure or load string component involves working inside the hazard area between the grips or fixtures. When working in this area, ensure that other personnel cannot operate any of the system controls. Keep clear of the jaws of a grip or fixture at all times. Keep clear of the hazard area between the grips or fixtures during actuator or crosshead movement. Ensure that all actuator or crosshead movements necessary for installation or removal are slow and, where possible, at a low force setting.



Flying Debris Hazard - Make sure that test specimens are installed correctly in grips or fixtures in order to eliminate stresses that can cause breakage of grip jaws or fixture components.

Incorrect installation of test specimens creates stresses in grip jaws or fixture components that can result in breakage of these components. The high energies involved can cause the broken parts to be projected forcefully some distance from the test area. Install specimens in the center of the grip jaws in line with the load path. Insert specimens into the jaws by at least the amount recommended in your grip documentation. This amount can vary between 66% to 100% insertion depth; refer to supplied instructions for your specific grips. Use any centering and alignment devices provided.



Flying Debris Hazard - Brittle specimens may shatter upon failure.

The high energies involved in testing can cause broken parts of a specimen to be projected forcefully some distance from the test area. Wear eye protection and use protective shields or screens whenever a risk of injury to operators and observers exists from the failure of a test specimen.



Select the correct test area for the test. An incorrectly set test area can cause unanticipated crosshead behavior. Press the Emergency Stop button if the frame moves in an unexpected direction.

An incorrectly set test area can cause unanticipated crosshead behavior and create a safety hazard that may damage the specimen or load cell. Verify the test area and test direction before starting a test.

1. Collect all specimens together that will make up the testing sample.
2. Identify each specimen, e.g. by marking. Identifying each specimen helps match it to the appropriate specimen number in the completed sample test report.
3. Start the frame and open the software.

The system is in **DISABLED** mode.

4. Ensure that the crosshead travel limits are set. Refer to “[Set the crosshead limit stops](#)” on page 86.
5. Ensure that limits are set for each transducer (displacement, force, strain, and user-defined). Refer to “[Set the limits for a transducer](#)” on page 87.
6. Press the **UNLOCK** button on the frame control panel to transition the system to one of the following:
 - **SET UP** mode. System transitions to this mode if the interlock is open and an operator has access to the test area. The system is now restricted to the Operator Protection settings specified on the **Configuration > Frame** screen on the Admin tab.



*If the interlock behavior is set to **Disable frame** then pressing the **UNLOCK** button with the interlock open has no effect. You must close the interlock to enable the frame.*

- **CAUTION** mode. System transitions to this mode if the interlock is closed and there is no access to the test area. The system can operate up to its full capacity.
7. In the software, create a new sample file. Refer to “[Create a new sample](#)” on page 80
 8. Verify that the test area is correct in System Details. Select **Frame** under Method settings.
 9. If necessary, calibrate the transducer configurations required by the test method. Refer to “[Calibrate a transducer](#)” on page 81.
If the frame was previously off, allow the load cell to warm up for at least 20 minutes to ensure stable readings.
 10. Measure the required specimen dimensions for each specimen and enter the values into the appropriate fields in the operator inputs component of the test workspace.
 11. Use the jog controls to move the crosshead to its starting position and set zero displacement. Refer to “[Set the zero displacement point](#)” on page 85.

12. Balance the Force transducer configuration. Refer to [“Balance a transducer configuration”](#) on page 87
13. Open the interlock. The system behavior depends upon how the interlock behavior is configured under Operator Protection:
 - **Disable frame** option: the system transitions to **DISABLED** mode when the interlock is open. You must close the interlock to enable the frame and move the crosshead, if necessary.
 - **Allow limited motion** option: the system transitions to **SET UP** mode when the interlock is open. You can use the jog keys to move the crosshead when the interlock is open. The crosshead is limited to the jog rate specified under Operator Protection.
14. Install the specimen into the grips. Refer to the documentation provided with the grips for details.

If the system includes pneumatic grips, refer to [“Pneumatic Grips”](#) on page 63.
15. Verify that the specimen is aligned properly in the grips.
16. Balance each of the remaining transducer configurations, e.g. strain. Refer to [“Balance a transducer configuration”](#) on page 87
17. Close the interlock.

The system transitions to **CAUTION** mode.
18. Press the **START** button on the frame control panel to start the test
The test will only start if the software displays the test workspace.
19. Upon starting the test, the various components on the test workspace update as the test proceeds. Some components will not update until the test is complete.
20. To stop the test before it completes, press the **STOP** button on the frame control panel.

Warning



In an emergency situation, press the large, round, red button on the frame to stop the test immediately and disable the frame.

Refer to [“Emergency Stop Button”](#) on page 88.

21. After the test is complete, the system transitions to **CAUTION** mode.

If the specimen did not break, use the jog controls to relieve the applied force from the specimen before opening the interlock to remove the specimen.

22. Open the interlock to remove the specimen pieces from each grip. The system behavior depends upon how the interlock behavior is configured under Operator Protection:
 - **Disable frame** option: the system transitions to **DISABLED** mode when the interlock is open. You must close the interlock to enable the frame and move the crosshead, if necessary.
 - **Allow limited motion** option: the system transitions to **SET UP** mode when the interlock is open. You can use the jog keys to move the crosshead when the interlock is open. The crosshead is limited to the jog rate specified under Operator Protection.
23. Close the interlock.

The system transitions to **CAUTION** mode.
24. Complete any post-test inputs that the test method requires, e.g. final specimen dimensions, specimen notes.
25. If necessary, press the **RETURN** button on the frame control panel to return the crosshead to its starting position.
26. After all specimens are tested, select **Finish sample** on the Test tab.



Create a new sample

To create a sample, you can either select an existing test method that contains the settings and parameters for the test (see below) or create a new method for the sample (refer to the Bluehill[®] online help and reference).

To select an existing method file:

1. Select **Test** on the **Home** screen.
2. Under **New Sample**, select a test method. You can either:
 - select a method shown under **Methods**. These are the most recently used method files.
 - select **Browse methods** to find a specific method file.

The system creates a sample based on the test parameters specified in the method file and advances to the Test tab.



The sample is initiated when the system advances to the Test tab. It is not yet saved as a file. The sample will be saved as file upon finishing the sample or when you select the **Save** button on the Test tab.

Calibrate a transducer

Automatic calibration of a force or strain transducer

Warning



Do not adjust the current calibration point value for an automatic calibration without first contacting Instron[®] Service. Adjusting the calibration point can negatively affect the validity of the data from the transducer.

A strain transducer can be an LVDT transducer. If the system identifies the strain transducer as an LVDT transducer, the Calibration point field becomes available for automatic calibration. The calibration point field is intended primarily for Instron[®] Service and should only be used by the service personnel. Contact Instron[®] Service for assistance.

1. Select  in the console area to open System Details.
2. In the System Settings area, select the icon for the transducer to open the Transducer Settings dialog.
3. Under Settings, select the transducer configuration in the **Transducer configuration** field.
4. Ensure that **Calibration type** is set to **Automatic**.

Automatic calibration uses the following basis for the calibration point value:

Force	50% of the full-scale load transducer
Strain	100% of the full-scale strain transducer

5. Set the transducer to its zero point.
For force, zero point means no load on the system.
For strain, zero point means the starting point of the strain transducer (e.g. extensometer)
6. Select **Calibrate**.
7. Follow the instructions provided in the Transducer Settings dialog and then select **OK** to proceed with the calibration.

Calibrating... displays in the transducer live display area during calibration.

8. The calibration was successful if a value displays in the transducer live display area and the transducer icon in System Details is no longer grayed.
9. Close the Transducer Settings dialog.
10. Close System Details.

The calibration is saved with the transducer configuration and is restored whenever the transducer configuration is selected.

The transducer is now calibrated and ready for testing. The transducer must be associated with a measurement in a method. Verify that the method used for testing includes a measurement that is linked to the transducer configuration for this transducer.

Manual calibration

During a manual calibration, you apply a measured physical force to the transducer and the system calibrates on the signal that is output as a result of that force. For force calibration, you can hang a measured weight from the load cell. For strain calibration, you can install the extensometer on a specially designed calibration jig to apply a precise deflection to the extensometer.

The system only saves the values entered for a manual calibration after there is a successful calibration. If you select a different transducer configuration or close the dialog before calibrating a transducer configuration, the calibration fields revert to the default values for that configuration.

Manual calibration of a rationalized force or strain transducer

1. Select  in the console area to open System Details.
2. In the System Settings area, select the icon for the transducer to open the Transducer Settings dialog.
3. Under Settings, select the transducer configuration in the **Transducer configuration** field.
4. Set **Calibration type** to **Manual**.
5. Enter a value for the calibration point. This value is the force (for a load cell) or deflection (for an extensometer) that you apply to the transducer during calibration.

For example, to calibrate a 100 kN load cell using a 50 kN weight, the full scale value is 100 kN and the calibration point is 50 kN.

The range for a valid calibration point value is between:

	Force (% full scale)	Strain (% full scale)
Minimum	2	2
Maximum	105	110
If you change the units for a field, the software converts the corresponding value to its equivalent value in the new units. Verify that the value is correct for the specified units.		

6. Select **Calibrate**.
7. Follow the instructions provided in the Transducer Settings dialog and select **OK** to proceed with the calibration:
 - a Set the transducer to its zero point or gauge length point.
 - b Deflect the transducer to its calibration point using a weight (load cell) or a calibration jig (extensometer).
For force, if you have a load cell with an associated electrical calibration circuit, you can use this to apply an electrical signal instead of applying a physical force to the load cell.
 - c Return the transducer to its zero point or gauge length point.

Calibrating... displays in the transducer live display area during calibration.
8. The calibration was successful if a value displays in the transducer live display area and the transducer icon in System Details is no longer grayed.
9. Close the Transducer Settings dialog.
10. Close System Details.

The calibration is saved with the transducer configuration and is restored whenever the transducer configuration is selected.

The transducer is now calibrated and ready for testing. The transducer must be associated with a measurement in a method. Verify that the method used for testing includes a measurement that is linked to the transducer configuration for this transducer.

Manual calibration of a non-rationalized force or strain transducer

1. Select  in the console area to open System Details.
2. In the System Settings area, select the icon for the transducer to open the Transducer Settings dialog.
3. Under Settings, select the transducer configuration in the **Transducer configuration** field.
4. Set **Calibration type** to **Manual**.

5. Enter the full scale value of the transducer.
6. For strain transducers, enter the gauge length of the extensometer.
The system must know the gauge length of the installed extensometer in order to calculate strain values for display and for further calculations.
7. Enter a value for the calibration point. This value is the force (for a load cell) or deflection (for an extensometer) that you apply to the transducer during calibration.
For example, to calibrate a 100 kN load cell using a 50 kN weight, enter 100 kN as the full scale value and 50 kN as the calibration point.

The range for a valid calibration point value is between:

	Force (% full scale)	Strain (% full scale)
Minimum	2	2
Maximum	105	110
If you change the units for a field, the software converts the corresponding value to its equivalent value in the new units. Verify that the value is correct for the specified units.		

8. Select **Calibrate**.
9. Follow the instructions provided in the Transducer Settings dialog and select **OK** to proceed with the calibration:
 - a Set the transducer to its zero point or gauge length point.
 - b Deflect the transducer to its calibration point using a weight (load cell) or a calibration jig (extensometer).
For force, if you have a load cell with an associated electrical calibration circuit, you can use this to apply an electrical signal instead of applying a physical force to the load cell.
 - c Return the transducer to its zero point or gauge length point.

Calibrating... displays in the transducer live display area during calibration.
10. The calibration was successful if a value displays in the transducer live display area and the transducer icon in System Details is no longer grayed.
11. Close the Transducer Settings dialog.
12. Close System Details.

The calibration is saved with the transducer configuration and is restored whenever the transducer configuration is selected.

The transducer is now calibrated and ready for testing. The transducer must be associated with a measurement in a method. Verify that the method used for testing includes a measurement that is linked to the transducer configuration for this transducer.

Set the zero displacement point

Setting the zero displacement point sets the transducer value to zero. This identifies the current position as the starting point from which total crosshead displacement is measured during a test. This effectively balances the displacement transducer.



“Zero displacement” is also known as “Reset the gauge length” or “Balance displacement”.

1. Use the jog controls to move the crosshead to its starting position for the test.
2. Select  in the console area to open System Details.
3. In the System Settings area, select the Displacement settings icon to open the Transducer Settings dialog.
4. Under **Displacement**, select the **Zero** button.
5. Close the Transducer Settings dialog.
6. Close System Details.



*Shortcut: If you have Displacement set up in your live displays, select it and select the **Zero** button in the dialog that appears.*

Crosshead limit stops

Warning



Crush hazard - you must set the crosshead travel limits as protection against unexpected crosshead movement.

Although Bluehill lets you set limits of travel in the software, you must set the crosshead travel limits as well. These hardware limits provide an absolute limit of travel that operates independently of the software.

Set the crosshead limits stops after you have established the crosshead starting position, but before you start a test.

The crosshead limit stops are two adjustable blocks mounted on the limit switch rod, which is located inside the column of the machine, as shown in [Figure 11](#) on page [86](#). Limit stops (1 and 2) have thumbscrews that you tighten and release by hand, and you can move them to any position on the limit rod. Position these stops just beyond the test parameters to prevent crosshead over-travel. When the crosshead reaches the maximum pre-set travel, the limit switch actuator (3) contacts one of these stops. Contact between the limit actuator and the limit stop moves the limit switch rod (4) and activates the limit switches. This stops crosshead motion.

There is an additional, second level of crosshead limit stop that is activated if the first level switch malfunctions. Activating a second-level limit switch disables the drive system so you cannot move the crosshead. The second level limits are internal to the machine. They are calculated relative to the first level limits and cannot be independently set.

Set the crosshead limit stops

1. Ensure that the crosshead is stationary and that the test parameters are set.



When setting limit stops, allow for an additional 3 mm of crosshead travel after the actuator activates a limit stop. There is a small delay time from the point when the actuator hits the limit stop and when the message relays to the limit switches located in the frame base.

2. Set the upper limit stop at a position just above the expected maximum crosshead travel in the upward direction when tension testing, or just above the test starting point when compression testing. Tighten the stop securely on the limit rod.
3. Set the lower limit stop at a position just below the starting position when tension testing or just below the expected maximum crosshead travel in the down direction when compression testing. Tighten the stop securely on the limit rod.

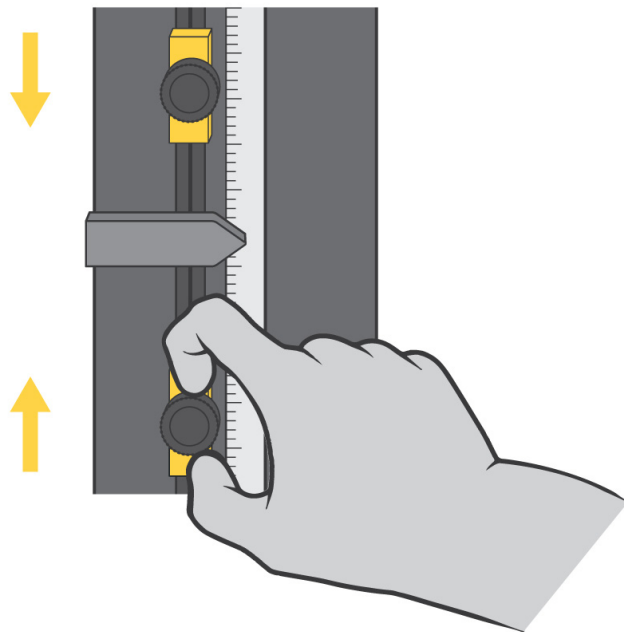

Figure 11. Setting Limit Stops

Caution

Do not use limit stops to end a test.

The limit stops are not intended to be an end of test condition to end every test. Repeated use of the limit stops in this way may cause excessive wear, which can result in the limit stop failing to stop the crosshead. Proper end of test conditions can be set from the software. Refer to the online help system for further assistance.

Move Off a Crosshead Limit Stop

The test stops if the crosshead contacts the upper or lower limit stops. If this happens, use the jog controls to move the crosshead away from the limit.

Set the limits for a transducer

1. Select  in the console area to open System Details.
2. In the System Settings area, select the icon for the transducer to open the Transducer Settings dialog.
3. Select **Limits**.
4. Select **Enabled** to activate the Maximum and Minimum limits.
The system activates the related fields. If **Enabled** is not selected, the system does not monitor the transducer for that limit value.
5. Enter a value for the Maximum limit.
If you change the units for a field, the software converts the corresponding value to its equivalent value in the new units.
6. Enter a value for the Minimum limit.
7. Close the Transducer Settings dialog.
8. Close System Details.

These settings are saved with the transducer configuration and are restored whenever the transducer configuration is selected.

Balance a transducer configuration

Calibrate the transducer before you balance it.

1. Make sure that no specimen is installed.
2. Select **E** in the console area to open System Details.
3. In the System Settings area, select the icon for the transducer to open the Transducer Settings dialog.
4. Under Settings, select the transducer configuration in the **Transducer configuration** field.
5. Select **Balance**.
The system removes any offsets caused by minor electrical or mechanical changes and resets the current transducer value to zero.
6. Close the Transducer Settings dialog.
7. Close System Details.

You can also:

- Select the live display that represents the transducer in the console area of the main screen and use the **Balance** button in the dialog.
- set a soft key to **Balance** a specific source transducer.
- set a soft key to **Balance all**.

Stop a test

You can stop a test by using hardware controls on the machine or settings in the software.

Emergency Stop Button



Figure 12. Emergency Stop Button

The Emergency Stop button on the testing system is a large, round, red button with a yellow background. Press this button to stop the test as soon as possible when a condition develops that:

- Could affect the safety of persons operating the system.
- Could damage the specimen, load frame, or test fixtures.

Investigate and resolve the situation that caused the use of the Emergency Stop button before you reset the system.

When operated, the Emergency Stop button locks into the closed position and the system is disabled until you reset the button and re-enable the load frame.

Warning



If you are using an integrated air kit with a foot switch to control a set of pneumatic grips, be aware that pressing the Emergency Stop button to disable the frame will also deactivate the grips, causing them to open.

With an integrated air kit, any action that disables the frame will also open the grips.

Warning



If you are using hydraulic grips, be aware that pressing the Emergency Stop button to disable the frame will lock the grips in their current position, prohibiting any further motion.

Re-enable the load frame

To reset the Emergency Stop button, rotate the button a quarter-turn clockwise until it resets.

The steps to re-enable the frame are different between a system with and without an interlock.

- In a system without interlocks:
 - a. Press the **UNLOCK** button on the frame control panel.

The frame proceeds to **SET UP** mode.
- In a system with interlocks:
 - a. Open the interlock.

- b. Close the interlock.
- In addition, in a system with interlocks where the interlock behavior is configured under Operator Protection to **Allow limited motion**:
 - a. Press the **UNLOCK** button on the frame control panel.

Crosshead Limit Switches

The test stops if the crosshead contacts the upper or lower limit stops. If this happens, use the jog controls to move the crosshead away from the limit.

Software Event

When the system encounters a pre-set limit or event set from the software, the test stops. The crosshead stops moving.

Shut down the system

Wait until the system completes all active tasks before shutting it off or disconnecting the electrical power.

Shut off the power to the system before you:

- Perform any maintenance procedure on the load frame.
- Disconnect the main power cable.
- Move the load frame.
- Connect or install optional components or accessories.

Turn the system off

1. Complete the test.
2. Remove the specimen.
3. Save any samples and test methods that may be open.
4. Exit the software and turn off the computer.

The **DISABLED** indicator flashes.

5. Shut off all any other components or accessories to the test system.
6. Switch the power for the load frame to the Off (O) position. The **DISABLED** indicator light no longer illuminates.

Troubleshooting

A Software Transducer Limit Trips

If the system trips a transducer limit, you must remove the condition that caused it to trip and the limit resets.

For example, if you set a load of 10 kN and the crosshead moves to or beyond a point that imposes a load of 10 kN on the specimen, you cannot proceed until you remove the limit condition.

Use the jog buttons to drive the crosshead in the direction necessary to remove the limit condition.

A Crosshead Travel Limit Trips

The test stops if the crosshead contacts the upper or lower limit stops. If this happens, use the jog controls to move the crosshead away from the limit.

Second Level Limit Stops

The second level limit switch acts as a backup if the first level switch (the limit stops) malfunctions. Activating a second-level limit switch disables the drive system so you cannot move the crosshead. The second level limits are internal to the machine. They are calculated relative to the first level limits and cannot be independently set.

Warning



Hazard - Identify and resolve the condition that caused the operation of the secondary overtravel limit before you use the testing system.

Operation of a secondary overtravel limit indicates a serious problem with your testing system, not least that the primary overtravel limit may have failed. Identify and resolve the condition that caused the secondary overtravel limit to trip before you use the testing system again. Contact Instron[®] Service for assistance.

You press the Emergency Stop button

Refer to [“Emergency Stop Button”](#) on page 88.

Chapter 8

Maintenance

• Preventive Maintenance	93
• Load frame maintenance	94
• Retrofit Controller maintenance	94
• Ancillary parts	94

Warnings



Hazard - Only qualified personnel, trained to service Instron[®] machines, should perform all internal maintenance procedures.

Instron[®] machines must operate within stringent specifications. In order to keep the system working within the stated safety specifications, a professionally trained and qualified technician must perform most maintenance procedures. If unqualified personnel perform any maintenance procedures not described in this manual, the machine may not perform to its stated specifications.



Hazard - Do not remove covers to any component of your system, unless it is specified in a procedure.

There are dangerous voltages and rotating machinery inside the machine that may cause bodily injury or damage to equipment.

Preventive Maintenance

Preventive maintenance is the periodic inspection, cleaning, and lubrication of the test system. The following sections provide guidelines for preventive maintenance.

To ensure that the frame continues working at its optimal performance, it is recommended that the machine receive an annual service check. Instron[®] Service can perform this annual service, and replace any damaged or worn parts to ensure that your machine operates to its stated specifications.

Instron[®] offers many service agreements that provide a variety of services, including annual service visits. Contact Instron[®] Service for details on a service agreement or contract that best matches your needs.

If your testing application generates debris, particularly conductive or abrasive dust, refer to “[Ingress Protection](#)” on page 32 for additional maintenance advice.

Load frame maintenance

Refer to the documentation provided with your original system for maintenance procedures including daily checks, periodic inspections and testing limit stops.

Retrofit Controller maintenance

Keep the surfaces of the Retrofit Controller clean and free from dust. There are no user-replaceable parts on this equipment.

Ancillary parts

This section lists the ancillary parts that are included with the system upon delivery. These components are either required to complete the installation, or facilitate setting up load cells and accessories on the load frame. Keep these components in a safe place.

Parts list

Table 11. Ancillary parts

Description	Part Number	Quantity	Purpose
Cable tie	11-10-1001	10	Cable management
Cable tie hook and loop	11-10-1027	10	Cable management
Cable tie	11-10-2	10	Cable management
Cable clip locking, adhesive base	11-2-17	4	Cable management
P-clip, vinyl coated	11-2-206	4	Cable management
Cable clamp mount, self-adhesive	11-6-21	4	Cable management

Table 11. Ancillary parts (Continued)

Description	Part Number	Quantity	Purpose
Cable clip	11-6-60	4	Cable management
Cable clip	11-6-62	4	Cable management
Cable clip	11-6-65	1	Cable management
Screw M6 x 12	204E142	6	Cable management
Screw M6 x 50	204H181	2	Cable management
Clamp	P636-740	2	Cable management
Tywrap	930770012	1	Cable management
3 MTS Ground cable	A712-213	1	Used to connect the frame to a suitable ground where the mains power supply is not grounded
CAT5E patch cable, 3m black	P636-647	1	For communication between the Retrofit Controller and the frame base



www.instron.com